

TAS5421-Q1 22-W Mono Automotive Digital-Audio Amplifier With Load Dump and I²C Diagnostics

1 Features

- Mono BTL Digital Power Amplifier
- 22-W Output Power at 10% THD+N into 4 Ω
- 4.5-V to 18-V Operating Range
- 85% Efficiency into 4 Ω
- Differential Analog Input
- Speaker Guard™ Speaker Protection with Adjustable Power Limiter
- 75-dB Power-Supply Rejection Ratio (PSRR)
- Load Diagnostic Functions:
 - Open and Shorted Output Load
 - Output-to-Power and Output-to-Ground Shorts
- Protection and Monitoring Functions:
 - Short-Circuit Protection
 - 40-V Load Dump Protection per ISO-7637-2
 - Output DC Level Detection while Music is Playing
 - Overtemperature Protection
 - Overvoltage and Undervoltage Protection
- Thermally Enhanced 16-Pin HTSSOP (PWP) Package with PowerPAD™ Package (Pad Down)
- Designed for Automotive EMC Requirements
- Qualified According to AEC-Q100 Grade 2
- ISO9000: 2002 TS16949 Certified
- –40°C to 125°C Ambient Temperature Range

2 Applications

- Automotive Emergency Call (eCall) Amplifier
- Telematics Systems
- Instrument Cluster Systems
- Infotainment Audio

3 Description

The TAS5421-Q1 is a mono digital audio amplifier, ideal for use in automotive emergency call (eCall), telematics, instrument cluster, and infotainment applications. The device provides up to 22 W into 4 Ω at less than 10% THD+N from a 14.4-Vdc automotive battery. The wide operating voltage range and excellent efficiency make the device ideal for start-stop support or running from a backup battery when required. The integrated load-dump protection reduces external voltage clamp cost and size, and the onboard load diagnostics report the status of the speaker through I²C.

Device Information⁽¹⁾

PART NUMBER	PACKAGE	BODY SIZE (NOM)
TAS5421-Q1	HTSSOP (16)	5.00 mm x 4.40 mm

(1) For all available packages, see the orderable addendum at the end of the datasheet.

Simplified Block Diagram

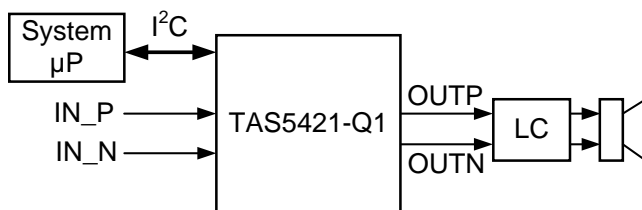

Output Power Efficiency

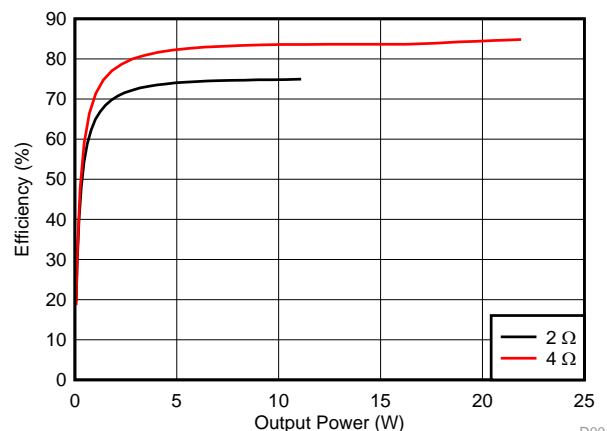

D001



Table of Contents

1 Features	1	7.5 Register Maps	18
2 Applications	1	8 Application and Implementation	20
3 Description	1	8.1 Application Information.....	20
4 Revision History	2	8.2 Typical Application	20
5 Pin Configuration and Functions	4	9 Power Supply Recommendations	23
6 Specifications	5	10 Layout	23
6.1 Absolute Maximum Ratings	5	10.1 Layout Guidelines	23
6.2 ESD Ratings	5	10.2 Layout Examples.....	23
6.3 Recommended Operating Conditions.....	5	11 Device and Documentation Support	26
6.4 Thermal Information	6	11.1 Device Support.....	26
6.5 Electrical Characteristics.....	6	11.2 Documentation Support	26
6.6 Timing Requirements for I ² C Interface Signals.....	8	11.3 Receiving Notification of Documentation Updates	26
6.7 Typical Characteristics.....	9	11.4 Community Resource.....	26
7 Detailed Description	11	11.5 Trademarks	26
7.1 Overview	11	11.6 Electrostatic Discharge Caution.....	26
7.2 Functional Block Diagram	11	11.7 Glossary	26
7.3 Feature Description.....	11	12 Mechanical, Packaging, and Orderable	
7.4 Device Functional Modes.....	17	Information	27

4 Revision History

NOTE: Page numbers for previous revisions may differ from page numbers in the current version.

Changes from Revision C (September 2014) to Revision D	Page
• Added the FAULT pin to the Input voltage parameters in the <i>Absolute Maximum Ratings</i> table	5
• Added the MUTE pin to the logic-level high and logic-level low parameters for the STANDBY in the <i>Recommended Operating Conditions</i> table	5
• Added the capacitance parameter to the <i>Electrical Characteristics</i> table for the SDA pin in STANDBY mode	7
• Added the <i>Receiving Notification of Documentation Updates</i> section	26

Changes from Revision B (July 2014) to Revision C	Page
• Moved T _{stg} from Handling Ratings table to Absolute Maximum Ratings table	5
• Changed Handling Ratings table to ESD Ratings	5
• In "1. Load Diagnostics" paragraph, changed "at start-up" to "on de-assertion of STANDBY" and appended two new sentences	13
• Changed Section number of <i>I²C Serial Communication Bus</i> from 7.4 to 7.3.7	14
• Changed Table 3	17
• Added disclaimer to beginning of <i>Application and Implementation</i> section	20
• Added <i>Power Supply Recommendations</i> section and moved the contents of former Section 8.2.1.5 here.....	23
• Placed text ahead of graphics for Figure 18 through Figure 21	23
• Created a <i>Layout Examples</i> section to contain former sections 9.1.1 through 9.1.4.....	23
• Added third-party component disclaimer	26

Changes from Revision A (July 2014) to Revision B	Page
• Changed data-sheet status from PRODUCT PREVIEW to PRODUCTION DATA	1

Changes from Original (March 2014) to Revision A**Page**

-
- Added content to the preliminary data sheet to create the full PRODUCT PREVIEW data sheet [4](#)
-

5 Pin Configuration and Functions

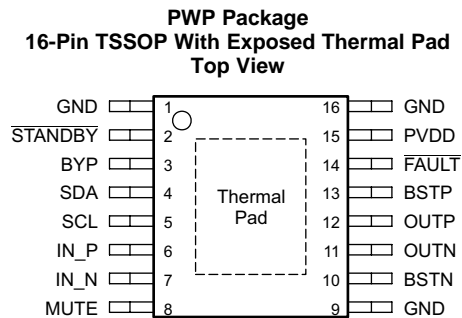

Pin Functions

PIN		TYPE ⁽¹⁾	DESCRIPTION
NAME	NO.		
BSTN	10	AI	Bootstrap for negative-output high-side FET
BSTP	13	AI	Bootstrap for positive-output high-side FET
BYP	3	PBY	Voltage-regulator bypass-capacitor pin
$\overline{\text{FAULT}}$	14	DO	Active-low open-drain output used to report faults
GND	1	GND	Ground
	9		
	16		
IN_N	7	AI	Inverting analog input
IN_P	6	AI	Non-inverting analog input
MUTE	8	DI	Mute input, active-high (no internal pullup or pulldown)
OUTN	11	PO	Output (-)
OUTP	12	PO	Output (+)
PVDD	15	PWR	Power supply
SCL	5	DI	I ² C clock
SDA	4	DI/DO	I ² C data
$\overline{\text{STANDBY}}$	2	DI	Active-low STANDBY pin (no internal pullup or pulldown)
Thermal pad	—	—	Must be soldered to ground

(1) DI = digital input, DO = digital output, AI = analog input, PWR = power supply, PBY = power bypass, PO = power output, GND = ground

6 Specifications

6.1 Absolute Maximum Ratings

over operating free-air temperature range (unless otherwise noted) ⁽¹⁾

			MIN	MAX	UNIT
Input voltage	DC supply voltage range, $V_{(PVDD)}$	Relative to GND	-0.3	30	V
	Pulsed supply voltage range, $V_{(PVDD_MAX)}$	$t \leq 400$ ms exposure	-1	40	
	Supply voltage ramp rate, $\Delta V_{(PVDD_RAMP)}$			15	V/ms
	For SCL, SDA, and $\overline{STANDBY}$ pins	Relative to GND	-0.3	5	V
	For IN_N, IN_P, \overline{FAULT} , and MUTE pins	Relative to GND	-0.3	6.5	
Current	DC current on PVDD, GND and OUTx pins, $I_{(PVDD)}$, I_O			± 4	A
	Maximum current, on all input pins, $I_{(IN_MAX)}$ ⁽²⁾			± 1	mA
	Maximum sink current for open-drain pin, $I_{(IN_ODMAX)}$			7	
Storage temperature, T_{stg}			-55	150	°C

- (1) Stresses beyond those listed under *Absolute Maximum Ratings* may cause permanent damage to the device. These are stress ratings only, which do not imply functional operation of the device at these or any other conditions beyond those indicated under *Recommended Operating Conditions*. Exposure to absolute-maximum-rated conditions for extended periods may affect device reliability.
- (2) See the [Application and Implementation](#) section for information on analog input voltage and ac coupling.

6.2 ESD Ratings

			VALUE	UNIT
$V_{(ESD)}$ Electrostatic discharge	Human-body model (HBM), per AEC Q100-002 ⁽¹⁾		± 3500	V
	Charged-device model (CDM), per AEC Q100-011		± 1000	

- (1) AEC Q100-002 indicates that HBM stressing shall be in accordance with the ANSI/ESDA/JEDEC JS-001 specification.

6.3 Recommended Operating Conditions

			MIN	NOM	MAX	UNIT
$V_{(PVDD_OP)}$	Supply voltage range relative to GND. Includes ac transients, requires proper decoupling. ⁽¹⁾	4- Ω $\pm 20\%$ load (or higher)	4.5	14.4	18	V
		2- Ω $\pm 20\%$ load	5	14.4	18	
$V_{(PVDD_RIPPLE)}$	Maximum ripple on PVDD	$V_{(PVDD)} < 8$ V			1	V_{pp}
$V_{(AIN)}$ ⁽²⁾	Analog audio input-signal level	AC-coupled input voltage	0		0.25–1 ⁽³⁾	V _{rms}
$V_{(IH_STANDBY)}$	MUTE and $\overline{STANDBY}$ pins input voltage for logic-level high		2			V
$V_{(IL_STANDBY)}$	MUTE and $\overline{STANDBY}$ pins input voltage for logic-level low				0.7	V
$V_{(IH_SCL)}$	SCL pin input voltage for logic-level high	$R_{(PU_I2C)} = 4.7\text{-k}\Omega$ pullup, supply voltage = 3.3 V or 5 V	2.1		5.5	V
$V_{(IH_SDA)}$	SDA pin input voltage for logic-level high	$R_{(PU_I2C)} = 4.7\text{-k}\Omega$ pullup, supply voltage = 3.3 V or 5 V	2.1		5.5	V
$V_{(IL_SCL)}$	SCL pin input voltage for logic-level low	$R_{(PU_I2C)} = 4.7\text{-k}\Omega$ pullup, supply voltage = 3.3 V or 5 V	-0.5		1.1	V
$V_{(IL_SDA)}$	SDA pin input voltage for logic-level low	$R_{(PU_I2C)} = 4.7\text{-k}\Omega$ pullup, supply voltage = 3.3 V or 5 V	-0.5		1.1	V
T_A	Ambient temperature		-40		125	°C
$R_{(L)}$	Nominal speaker load impedance	When using low-impedance loads, do not exceed overcurrent limit.	2	4	16	Ω
$V_{(PU)}$	Pullup voltage supply (for open-drain logic outputs)		3	3.3	3.6	V
$R_{(PU_EXT)}$	External pullup resistor on open-drain logic outputs	Resistor connected between open-drain logic output and $V_{(PU)}$ supply.	10		50	k Ω
$R_{(PU_I2C)}$	I ² C pullup resistance on SDA and SCL pins		1	4.7	10	k Ω
$C_{(PVDD)}$	External capacitor on the PVDD pin, typical value $\pm 20\%$ ⁽¹⁾			10		μ F

- (1) See the [Power Supply Recommendations](#) section.
- (2) Signal input for full unclipped output with gains of 36 dB, 32 dB, 26 dB, and 20 dB
- (3) Maximum recommended input voltage is determined by the gain setting.

Recommended Operating Conditions (continued)

		MIN	NOM	MAX	UNIT
$C_{(BYP)}$	External capacitor on the BYP pin, typical value $\pm 10\%$		1		μF
$C_{(OUT)}$	External capacitance to GND on OUT_X pins			4	μF
$C_{(IN)}$	External capacitance to analog input pin in series with input signal		1		μF
$C_{(BSTN)}, C_{(BSTP)}$	External bootstrap capacitor, typical value $\pm 20\%$		220		nF

6.4 Thermal Information

THERMAL METRIC ⁽¹⁾		TAS5421-Q1			UNIT
		PWP (HTSSOP)			
		16 PINS			
$R_{\theta JA}$	Junction-to-ambient thermal resistance	39.4			$^{\circ}\text{C}/\text{W}$
$R_{\theta JC(top)}$	Junction-to-case (top) thermal resistance	24.9			$^{\circ}\text{C}/\text{W}$
$R_{\theta JB}$	Junction-to-board thermal resistance	20			$^{\circ}\text{C}/\text{W}$
Ψ_{JT}	Junction-to-top characterization parameter	0.6			$^{\circ}\text{C}/\text{W}$
Ψ_{JB}	Junction-to-board characterization parameter	19.8			$^{\circ}\text{C}/\text{W}$
$R_{\theta JC(bot)}$	Junction-to-case (bottom) thermal resistance	2			$^{\circ}\text{C}/\text{W}$

(1) For more information about traditional and new thermal metrics, see the [Semiconductor and IC Package Thermal Metrics](#) application report.

6.5 Electrical Characteristics

$T_C = 25^{\circ}\text{C}$, $PVDD = 14.4\text{ V}$, $R_L = 4\ \Omega$, $P_{(O)} = 1\text{ W/ch}$, AES17 filter, default I²C settings (unless otherwise noted)

PARAMETER	TEST CONDITIONS	MIN	TYP	MAX	UNIT	
OPERATING CURRENT						
PVDD idle current	In PLAY mode, no audio present		16		mA	
PVDD standby current	STANDBY mode, MUTE = 0 V		5	20	μA	
OUTPUT POWER						
Output power per channel	4 Ω , THD+N $\leq 1\%$, 1 kHz, $T_C = 75^{\circ}\text{C}$		18		W	
	4 Ω , THD+N = 10%, 1 kHz, $T_C = 75^{\circ}\text{C}$		22			
Power efficiency	4 Ω , $P_{(O)} = 22\text{ W}$ (10% THD)		85%			
AUDIO PERFORMANCE						
Noise voltage at output	G = 20 dB, zero input, and A-weighting		65		μV	
Common-mode rejection ratio	f = 1 kHz, 100 mVrms referenced to GND, G = 20 dB		63		dB	
Power-supply rejection ratio	PVDD = 14.4 Vdc + 1 Vrms, f = 1 kHz		75			
Total harmonic distortion + noise	$P_{(O)} = 1\text{ W}$, f = 1 kHz		0.05%		dB	
Switching frequency	Switching frequency selectable for AM interference avoidance		400		kHz	
			500			
Internal common-mode input bias voltage	Internal bias applied to IN_N, IN_P pins		3		V	
Voltage gain (V_O / V_{IN})	Source impedance = 0 Ω , $P_{(O)} = 1\text{ W}$		19	20	21	dB
			25	26	27	
			31	32	33	
			35	36	37	
PWM OUTPUT STAGE						
FET drain-to-source resistance	$T_J = 25^{\circ}\text{C}$		180		m Ω	
Output offset voltage	Zero input signal, G = 20 dB			± 25	mV	

Electrical Characteristics (continued)

 $T_C = 25^\circ\text{C}$, $PVDD = 14.4\text{ V}$, $R_L = 4\ \Omega$, $P_{(O)} = 1\text{ W/ch}$, AES17 filter, default I²C settings (unless otherwise noted)

PARAMETER	TEST CONDITIONS	MIN	TYP	MAX	UNIT
PVDD OVERVOLTAGE (OV) PROTECTION					
PVDD overvoltage-shutdown set		19.5	21	22.5	V
PVDD overvoltage-shutdown hysteresis			0.6		V
PVDD UNDERVOLTAGE (UV) PROTECTION					
PVDD undervoltage-shutdown set		3.6	4	4.4	V
PVDD undervoltage-shutdown hysteresis			0.25		V
BYP					
BYP pin voltage		6.4	6.9	7.4	V
POWER-ON RESET (POR)					
PVDD voltage for POR				4.1	V
PVDD recovery hysteresis voltage for POR			0.3		V
OVERTEMPERATURE (OT) PROTECTION					
Junction temperature for overtemperature shutdown		155	170		°C
Junction temperature overtemperature shutdown hysteresis			15		°C
OVERCURRENT (OC) SHUTDOWN PROTECTION					
Maximum current (peak output current)			3.5		A
STANDBY PIN					
STANDBY pin current			0.1	0.2	μA
DC DETECT					
DC detect threshold			2.9		V
DC detect step response time				700	ms
FAULT REPORT					
$\overline{\text{FAULT}}$ pin output voltage for logic-level high (open-drain logic output)	External 47-kΩ pullup resistor to 3.3 V	2.4			V
$\overline{\text{FAULT}}$ pin output voltage for logic-level low (open-drain logic output)	External 47-kΩ pullup resistor to 3.3 V			0.5	V
LOAD DIAGNOSTICS					
Resistance to detect a short from OUT pin(s) to PVDD or ground				200	Ω
Open-circuit detection threshold	Including speaker wires	70	95	120	Ω
Short-circuit detection threshold	Including speaker wires	0.9	1.2	1.5	Ω
I²C					
SDA pin output voltage for logic-level high	$R_{(PU_I2C)} = 4.7\text{-k}\Omega$ pullup, supply voltage = 3.3 V or 5 V	2.4			V
SDA pin output voltage for logic-level low	3-mA sink current			0.4	V
Capacitance for SCL and SDA pins				10	pF
Capacitance for SDA pin	STANDBY mode		30		pF

6.6 Timing Requirements for I²C Interface Signals

over recommended operating conditions (unless otherwise noted)

		MIN	NOM	MAX	UNIT
$f_{(SCL)}$	SCL clock frequency			400	kHz
t_r	Rise time for both SDA and SCL signals			300	ns
t_f	Fall time for both SDA and SCL signals			300	ns
$t_{w(H)}$	SCL pulse duration, high	0.6			μ s
$t_{w(L)}$	SCL pulse duration, low	1.3			μ s
$t_{su(2)}$	Setup time for START condition	0.6			μ s
$t_{h(2)}$	START condition hold time before generation of first clock pulse	0.6			μ s
$t_{su(1)}$	Data setup time	100			ns
$t_{h(1)}$	Data hold time	0 ⁽¹⁾			ns
$t_{su(3)}$	Setup time for STOP condition	0.6			μ s
$C_{(B)}$	Load capacitance for each bus line			400	pF

- (1) A device must internally provide a hold time of at least 300 ns for the SDA signal to bridge the undefined region of the falling edge of SCL.

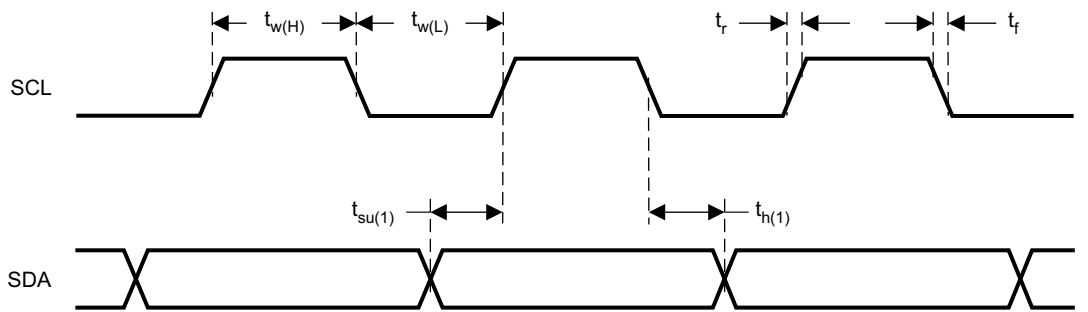

T0027-03

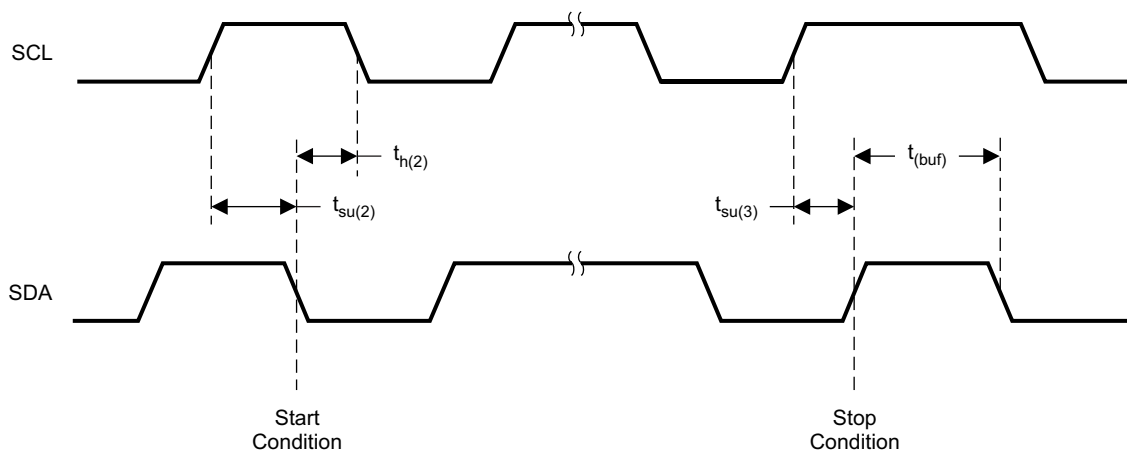
Figure 1. SCL and SDA Timing

T0028-02

Figure 2. Timing for Start and Stop Conditions

6.7 Typical Characteristics

PVDD = 14.4 V, T_A = 25°C, P_(O) = 1 W, 1-kHz input, default I²C settings (unless otherwise noted)

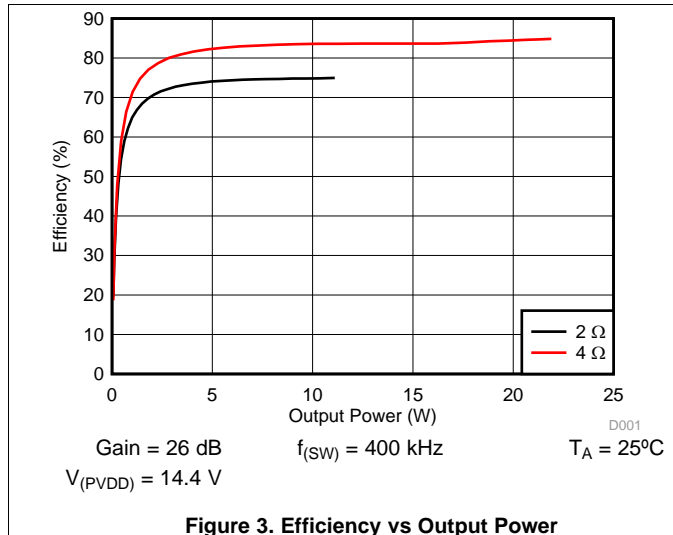

Figure 3. Efficiency vs Output Power

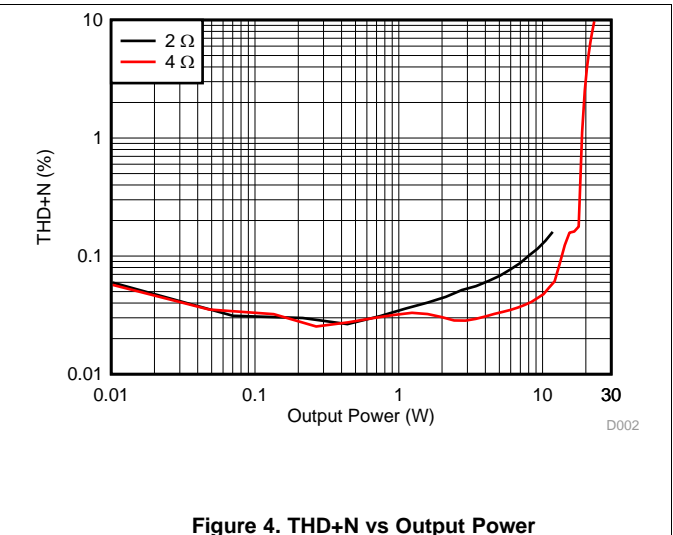

Figure 4. THD+N vs Output Power

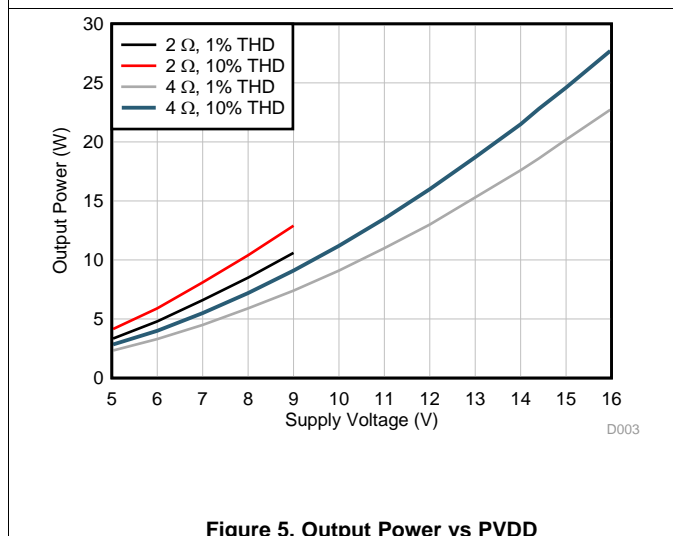

Figure 5. Output Power vs PVDD

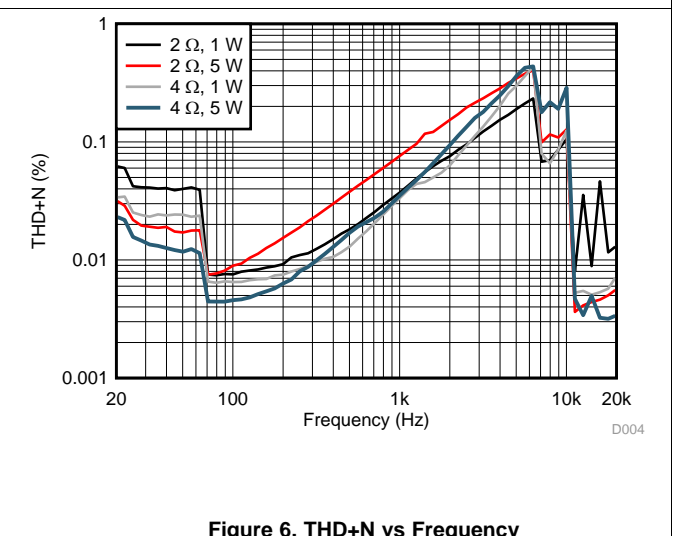

Figure 6. THD+N vs Frequency

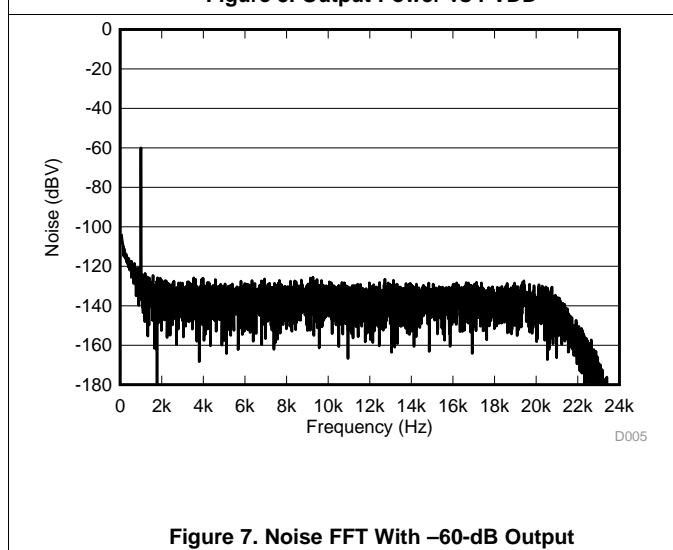

Figure 7. Noise FFT With -60-dB Output

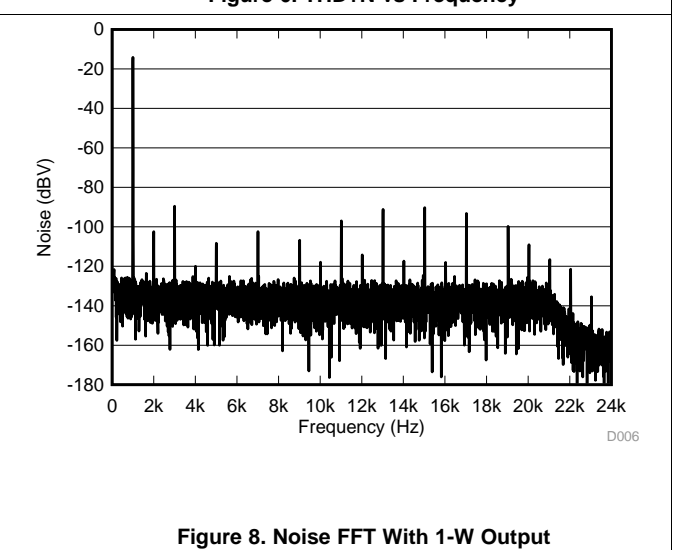
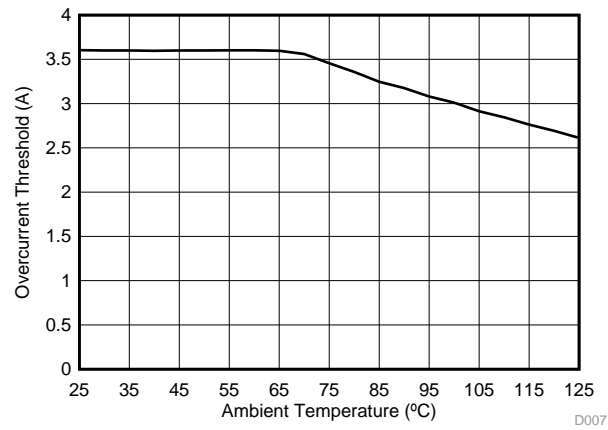

Figure 8. Noise FFT With 1-W Output

Typical Characteristics (continued)

 PVDD = 14.4 V, $T_A = 25^\circ\text{C}$, $P_{(O)} = 1\text{ W}$, 1-kHz input, default I²C settings (unless otherwise noted)

Figure 9. Overcurrent Threshold vs Temperature

7 Detailed Description

7.1 Overview

The TAS5421-Q1 is a mono analog-input audio amplifier for use in the automotive environment. The design uses an ultra-efficient class-D technology developed by Texas Instruments, but with features added for the automotive industry. The class-D technology allows for reduced power consumption, reduced heat, and reduced peak currents in the electrical system. The device realizes an audio sound system design with smaller size and lower weight than traditional class-AB solutions.

The TAS5421-Q1 device has seven core design blocks:

- PWM
- Gate drive
- Power FETs
- Diagnostics
- Protection
- Power supply
- I²C serial communication bus

7.2 Functional Block Diagram

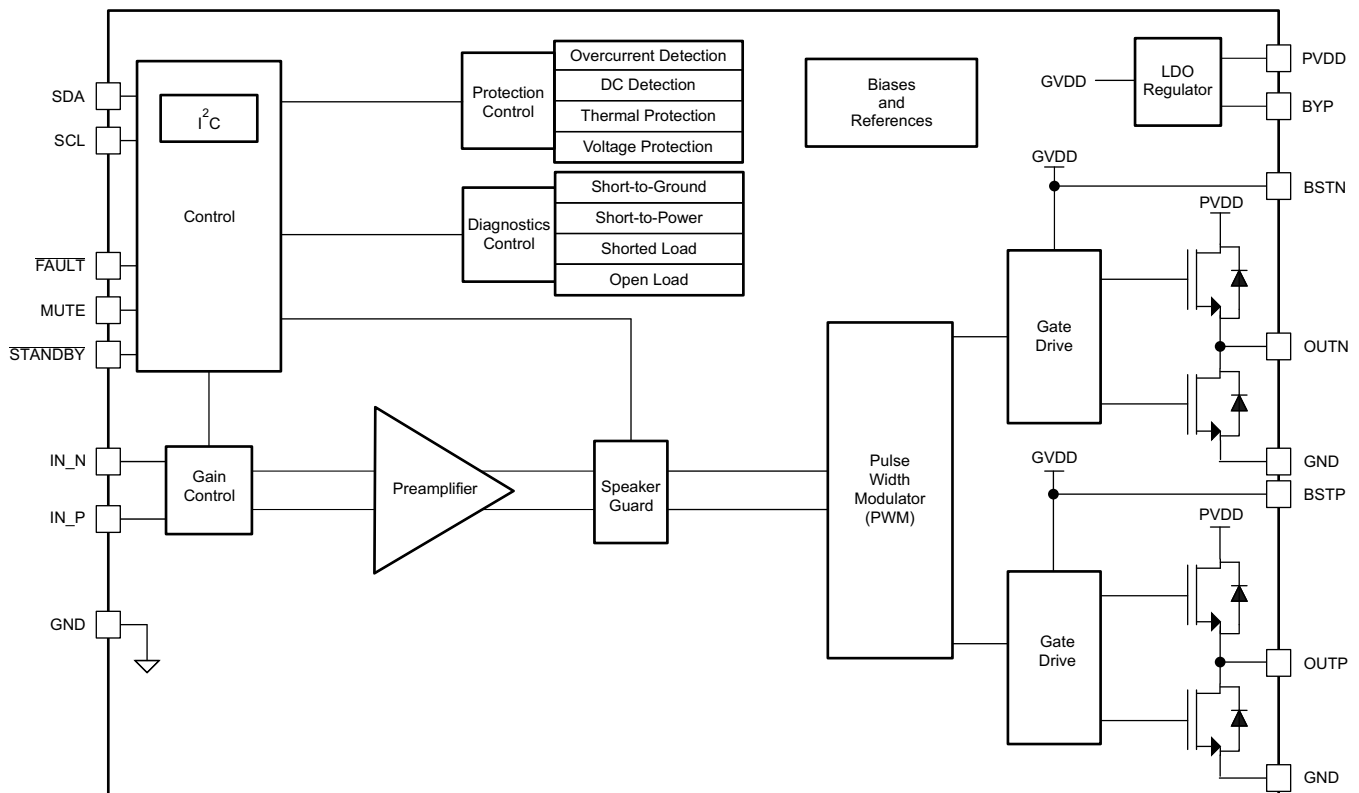

7.3 Feature Description

7.3.1 Analog Audio Input and Pre-amplifier

The differential input stage of the amplifier cancels common-mode noise that appears on the inputs. For a differential audio source, connect the positive lead to IN_P and the negative lead to IN_N. The inputs must be ac-coupled to minimize the output dc-offset and ensure correct ramping of the output voltages. For good transient performance, the impedance seen at each of the two differential inputs should be the same.

The gain setting impacts the analog input impedance of the amplifier. See [Table 1](#) for typical values.

Table 1. Input Impedance and Gain

Gain	Input Impedance
20 dB	60 k Ω \pm 20%
26 dB	30 k Ω \pm 20%
32 dB	15 k Ω \pm 20%
36 dB	9 k Ω \pm 20%

7.3.2 Pulse-Width Modulator (PWM)

The PWM converts the analog signal from the preamplifier into a switched signal of varying duty cycle. This is the critical stage that defines the class-D architecture. In the TAS5421-Q1, the modulator is an advanced design with high bandwidth, low noise, low distortion, and excellent stability.

The pulse-width modulation scheme allows increased efficiency at low power. Each output is switching from 0 V to PVDD. The OUTP and OUTN pins are in phase with each other with no input so that there is little or no current in the speaker. The duty cycle of OUTP is greater than 50% and the duty cycle of OUTN is less than 50% for positive output voltages. The duty cycle of OUTN is greater than 50% and the duty cycle of OUTP is less than 50% for negative output voltages. The voltage across the load is at 0 V through most of the switching period, reducing power loss.

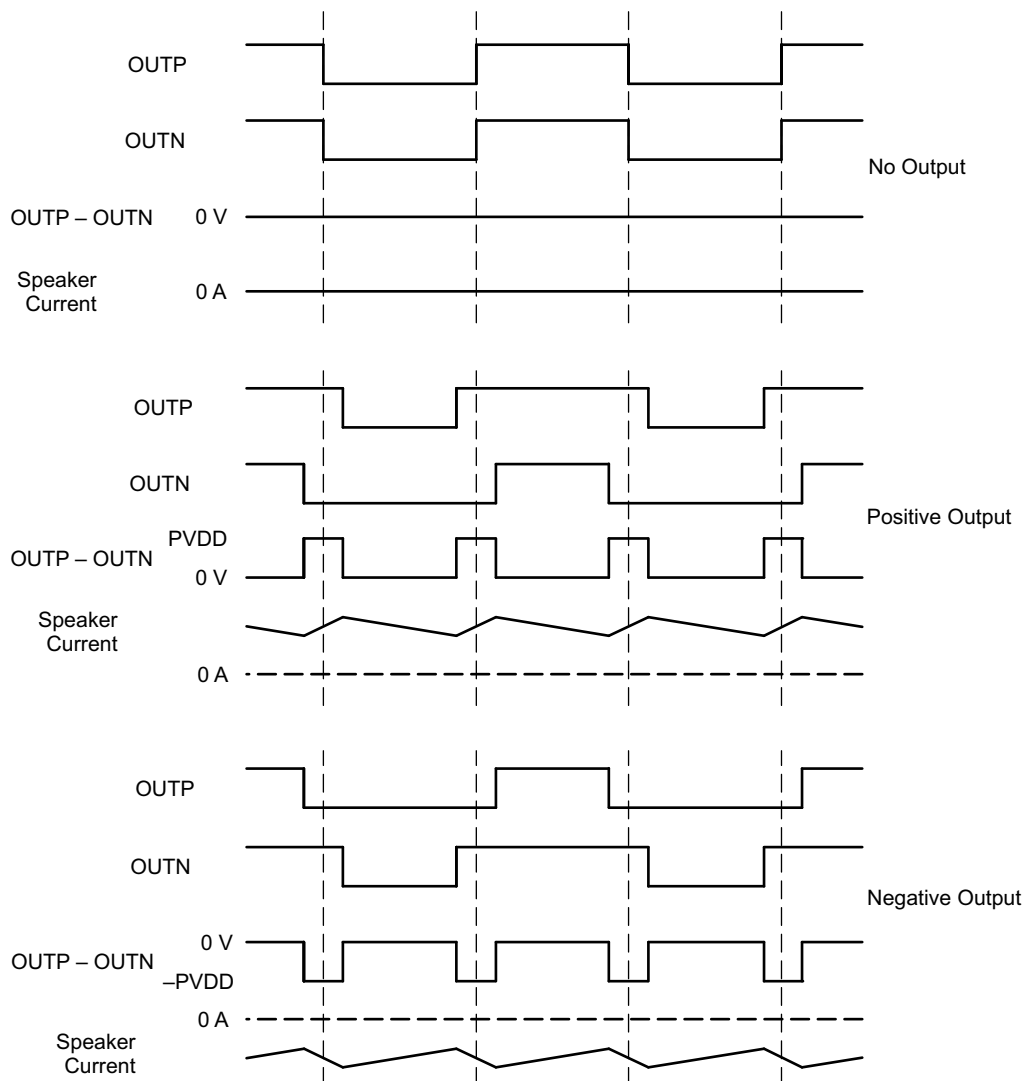
Figure 10. BD Mode Modulation

7.3.3 Gate Drive

The gate driver accepts the low-voltage PWM signal and level-shifts the signal to drive a high-current, full-bridge, power FET stage. The device uses proprietary techniques to optimize EMI and audio performance.

7.3.4 Power FETs

The BTL output comprises four matched N-channel FETs for high efficiency and maximum power transfer to the load. By design, the FETs withstand large voltage transients during a load-dump event.

7.3.5 Load Diagnostics

The device incorporates load diagnostic circuitry designed for detecting and determining the status of output connections. The device supports the following diagnostics:

- Short to GND
- Short to PVDD
- Short across load
- Open load

The device reports the presence of any of the short or open conditions to the system via I²C register read.

1. **Load Diagnostics**—The load diagnostic function runs on de-assertion of STANDBY or when the device is in a fault state (dc detect, overcurrent, overvoltage, undervoltage, and overtemperature). During this test, the outputs are in a Hi-Z state. The device determines whether the output is a short to GND, short to PVDD, open load, or shorted load. The load diagnostic biases the output, which therefore requires limiting the capacitance value for proper functioning; see the [Recommended Operating Conditions](#). The load diagnostic test takes approximately 229 ms to run. Note that the *check* phase repeats up to five times if a fault is present or a large capacitor to GND is present on the output. On detection of an open load, the output still operates. On detection of any other fault condition, the output goes into a Hi-Z state, and the device checks the load continuously until removal of the fault condition. After detection of a normal output condition, the audio output starts. The load diagnostics run after every other overvoltage (OV) event. The load diagnostic for open load only has I²C reporting. All other faults have I²C and FAULT pin assertion.

The device performs load diagnostic tests as shown in [Figure 11](#).

[Figure 12](#) illustrates how the diagnostics determine the load based on output conditions.

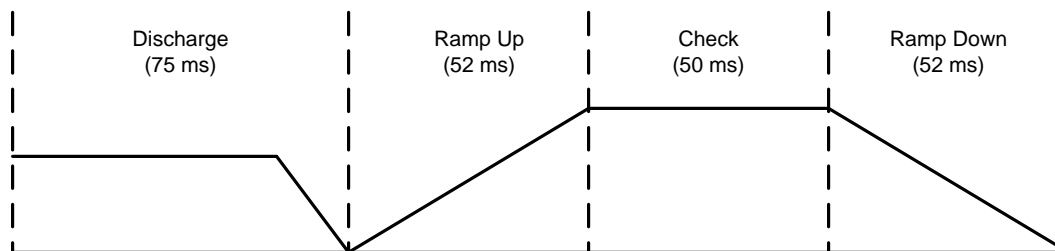

Figure 11. Load Diagnostics Sequence of Events

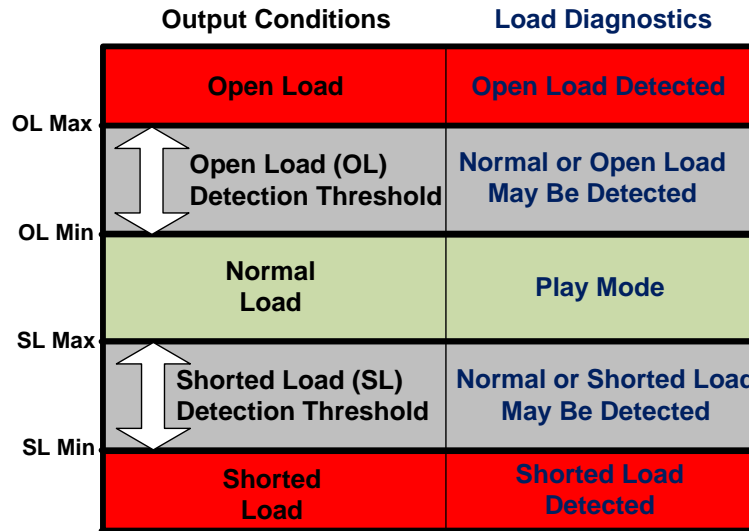

Figure 12. Load Diagnostic Reporting Thresholds

- Faults During Load Diagnostics**—If the device detects a fault (such as overtemperature, overvoltage, or undervoltage) during the load diagnostics test, the device exits the load diagnostics, which can result in a pop or click on the output.

7.3.6 Protection and Monitoring

- Overcurrent Shutdown (OCS)**—The overcurrent shutdown forces the output into Hi-Z. The device asserts the FAULT pin and updates the I²C register.
- DC Detect**—This circuit checks for a dc offset continuously during normal operation at the output of the amplifier. If a dc offset occurs, the device asserts the FAULT pin and updates the I²C register. Note that the dc detection threshold follows PVDD changes.
- Overtemperature Shutdown (OTSD)**—The device shuts down when the die junction temperature reaches the overtemperature threshold. The device asserts the FAULT pin asserts and updates I²C register. Recovery is automatic when the temperature returns to a safe level.
- Undervoltage (UV)**—The undervoltage (UV) protection detects low voltages on PVDD. In the event of an undervoltage condition, the device asserts the FAULT pin and resets the I²C register.
- Power-On Reset (POR)**—Power-on reset (POR) occurs when PVDD drops below the POR threshold. A POR event causes the I²C bus to go into a high-impedance state. After recovery from the POR event, the device restarts automatically with default I²C register settings. The I²C is active as long as the device is not in POR.
- Overvoltage (OV) and Load Dump**—OV protection detects high voltages on PVDD. If PVDD reaches the overvoltage threshold, the device asserts the FAULT pin and updates the I²C register. The device can withstand 40-V load-dump voltage spikes.
- SpeakerGuard**—This protection circuitry limits the output voltage to the value selected in I²C register 0x03. This value determines both the positive and negative limits. The user can use the SpeakerGuard feature to improve battery life or protect the speaker from exceeding its excursion limits.
- Adjacent-Pin Shorts**—The device design is such that shorts between adjacent pins do not cause damage.

7.3.7 I²C Serial Communication Bus

The device communicates with the system processor via the I²C serial communication bus as an I²C slave-only device. The processor can poll the device via I²C to determine the operating status. All reports of fault conditions and detections are via I²C. The system can also set numerous features and operating conditions via I²C. The I²C interface is active approximately 1 ms after the STANDBY pin is high.

The I²C interface controls the following device features:

- Changing gain setting to 20 dB, 26 dB, 32 dB, or 36 dB.
- Controlling peak voltage value of SpeakerGuard protection circuitry
- Reporting load diagnostic results
- Changing of switching frequency for AM radio avoidance

7.3.7.1 I²C Bus Protocol

The device has a bidirectional serial control interface that is compatible with the Inter IC (I²C) bus protocol and supports 400-kbps data transfer rates for random and sequential write and read operations. This is a slave-only device that does not support a multimaster bus environment or wait-state insertion. The master device uses the I²C control interface to program the registers of the device and to read device status.

The I²C bus employs two signals, SDA (data) and SCL (clock), to communicate between integrated circuits in a system. Data transfer on the bus is serial, one bit at a time. The transfer of address and data is in byte (8-bit) format with the most-significant bit (MSB) transferred first. In addition, the receiving device acknowledges each byte transferred on the bus with an acknowledge bit. Each transfer operation begins with the master device driving a start condition on the bus and ends with the master device driving a stop condition on the bus. The bus uses transitions on the data pin (SDA) while the clock is HIGH to indicate start and stop conditions. A HIGH-to-LOW transition on SDA indicates a start, and a LOW-to-HIGH transition indicates a stop. Normal data bit transitions must occur within the low time of the clock period. Figure 13 shows these conditions. The master generates the 7-bit slave address and the read/write (R/W) bit to open communication with another device and then waits for an acknowledge condition. The device holds SDA LOW during the acknowledge clock period to indicate an acknowledgment. When this occurs, the master transmits the next byte of the sequence. The address for each device is a unique 7-bit slave address plus a R/W bit (1 byte). All compatible devices share the same signals via a bidirectional bus using a wired-AND connection. The SDA and SCL signals require the use of an external pullup resistor to set the HIGH level for the bus. There is no limit on the number of bytes that the communicating devices can transmit between start and stop conditions. After transfer of the last word, the master generates a stop condition to release the bus.

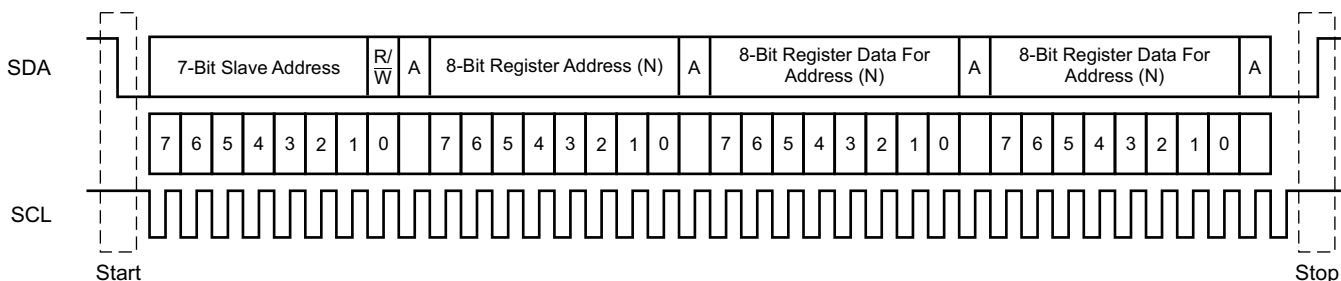

T0035-02

Figure 13. Typical I²C Sequence

To communicate with the device, the I²C master uses addresses shown in Figure 13. Transmission of read and write data can be by single-byte or multiple-byte data transfers.

7.3.7.2 Random Write

As shown in Figure 14, a single-byte data-write transfer begins with the master device transmitting a start condition followed by the I²C device address and the read/write bit. The read/write bit determines the direction of the data transfer. For a write data transfer, the read/write bit is a 0. After receiving the correct I²C device address and the read/write bit, the device responds with an acknowledge bit. Next, the master transmits the address byte corresponding to the internal memory address being accessed. After receiving the address byte, the device again responds with an acknowledge bit. Next, the master device transmits the data byte for writing to the memory address being accessed. After receiving the data byte, the device again responds with an acknowledge bit. Finally, the master device transmits a stop condition to complete the single-byte data-write transfer.

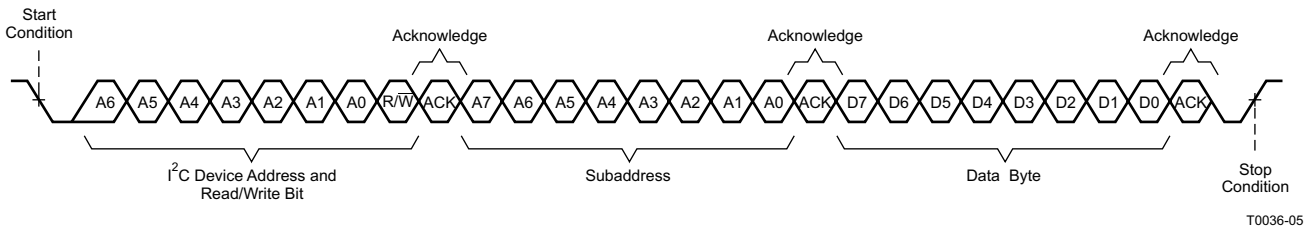

Figure 14. Random Write Transfer

7.3.7.3 Random Read

As shown in Figure 15, a single-byte data-read transfer begins with the master device transmitting a start condition followed by the I²C device address and the read/write bit. For the data-read transfer, the master device performs both a write and a following read. Initially, the master device performs a write to transfer the address byte of the internal memory address to be read. As a result, the read/write bit is a 0. After receiving the address and the read/write bit, the device responds with an acknowledge bit. In addition, after sending the internal memory address byte, the master device transmits another start condition followed by the device address and the read/write bit again. This time, the read/write bit is a 1, indicating a read transfer. After receiving the address and the read/write bit, the device again responds with an acknowledge bit. Next, the device transmits the data byte from the memory address being read. After receiving the data byte, the master device transmits a not-acknowledge followed by a stop condition to complete the single-byte data-read transfer.

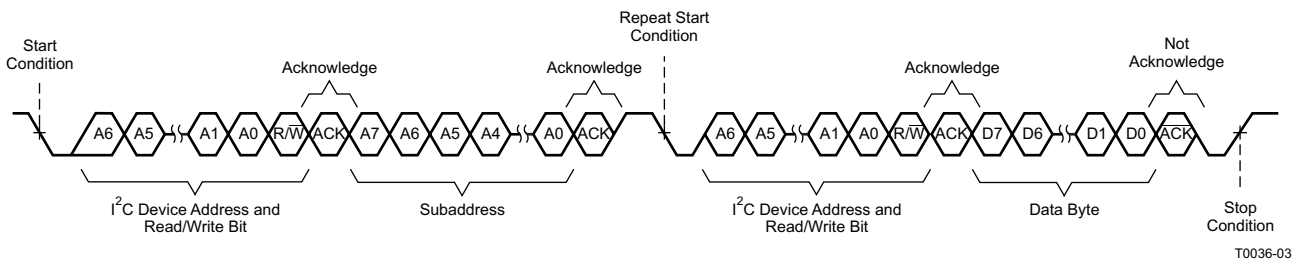

Figure 15. Random Read Transfer

7.3.7.4 Sequential Read

A sequential data-read transfer is identical to a single-byte data-read transfer except that the TAS5421-Q1 transmits multiple data bytes to the master device as shown in Figure 16. Except for the last data byte, the master device responds with an acknowledge bit after receiving each data byte and automatically increments the I²C subaddress by one. After receiving the last data byte, the master device transmits a not-acknowledge followed by a stop condition to complete the transfer.

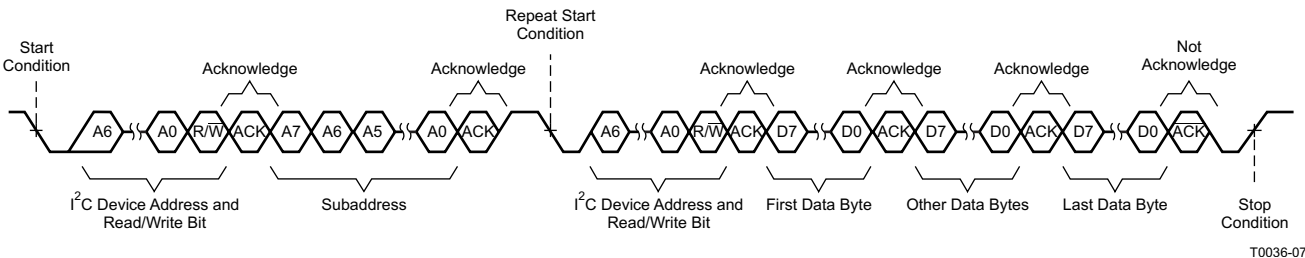

Figure 16. Sequential Read Transfer

7.4 Device Functional Modes

7.4.1 Hardware Control Pins

Three discrete hardware pins are available for real-time control and indication of device status.

1. **FAULT** pin: This active-low open-drain output pin indicates the presence of a fault condition which requires the device to go into the Hi-Z mode. On assertion of this pin, the device has protected itself and the system from potential damage. The system can read the exact nature of the fault via I²C with the exception of PVDD undervoltage faults below POR, in which case the I²C bus is no longer operational.
2. **STANDBY** pin: Assertion of this active-low pin sends the device goes into a complete shutdown, limiting the current draw.
3. **MUTE** pin: On assertion of this active-high pin, the device is in mute mode. The output pins stop switching and audio does not pass from the input to the output. To place the device back into play mode, deassert this pin.

7.4.2 EMI Considerations

Automotive-level EMI performance depends on both careful integrated-circuit design and good system-level design. Controlling sources of electromagnetic interference (EMI) was a major consideration in all aspects of the design.

The design has minimal parasitic inductances due to the short leads on the package, which dramatically reduces the EMI that results from current passing from the die to the system PCB. The design incorporates circuitry that optimizes output transitions that cause EMI.

7.4.3 Operating Modes and Faults

The following tables list operating modes and faults.

Table 2. Operating Modes

STATE NAME	OUTPUT	OSCILLATOR	I ² C
STANDBY	Hi-Z, floating	Stopped	Stopped
Load diagnostic	DC biased	Active	Active
Fault and mute	Hi-Z, floating	Active	Active
Play	Switching with audio	Active	Active

Table 3. Faults and Actions

FAULT EVENT	FAULT EVENT CATEGORY	MONITORING MODES	REPORTING METHOD	ACTION TYPE	ACTION RESULT	CLEARING
POR	Voltage fault	All	Not applicable	Hard mute (no ramp)	Standby	Self-clearing
UV or OV			I ² C + $\overline{\text{FAULT}}$ pin			
Load dump ⁽¹⁾			$\overline{\text{FAULT}}$ pin			
OTSD	Thermal fault	Hi-Z, mute, play	I ² C + $\overline{\text{FAULT}}$ pin		Hi-Z	
OC fault	Output channel fault	Play				
DC detect						
Load diagnostic - short	Diagnostic	Hi-Z	I ² C	None	Hi-Z, re-run diagnostics	
Load diagnostic - open				None	Clears on next diagnostic cycle	

(1) Tested in accordance with ISO7637-1

7.5 Register Maps

Table 4. I²C Address

DESCRIPTION	FIXED ADDRESS							READ/WRITE BIT	I ² C ADDRESS
	MSB	6	5	4	3	2	1	LSB	
I ² C write	1	1	0	1	1	0	0	0	0xD8
I ² C read	1	1	0	1	1	0	0	1	0xD9

7.5.1 I²C Address Register Definitions

Table 5. I²C Address Register Definitions

ADDRESS	R/ \bar{W}	REGISTER DESCRIPTION
0x01	R	Latched fault register
0x02	R	Status and load diagnostics register
0x03	R/ \bar{W}	Control register

Table 6. Fault Register (0x01)

D7	D6	D5	D4	D3	D2	D1	D0	FUNCTION
0	0	0	0	0	0	0	0	No protection-created faults, default value
–	–	–	–	–	–	–	1	Reserved
–	–	–	–	–	–	1	–	Reserved
–	–	–	–	–	1	–	–	A load-diagnostics fault has occurred.
–	–	–	–	1	–	–	–	Overcurrent shutdown has occurred.
–	–	–	1	–	–	–	–	PVDD undervoltage has occurred.
–	–	1	–	–	–	–	–	PVDD overvoltage has occurred.
–	1	–	–	–	–	–	–	DC offset protection has occurred.
1	–	–	–	–	–	–	–	Overtemperature shutdown has occurred.

Table 7. Status and Load Diagnostic Register (0x02)

D7	D6	D5	D4	D3	D2	D1	D0	FUNCTION
0	0	0	0	0	0	0	0	No speaker-diagnostic-created faults, default value
–	–	–	–	–	–	–	1	Output short to PVDD is present.
–	–	–	–	–	–	1	–	Output short to ground is present.
–	–	–	–	–	1	–	–	Open load is present.
–	–	–	–	1	–	–	–	Shorted load is present.
–	–	–	1	–	–	–	–	In a fault condition
–	–	1	–	–	–	–	–	Performing load diagnostics
–	1	–	–	–	–	–	–	In mute mode
1	–	–	–	–	–	–	–	In play mode

Table 8. Control Register (0x03)

D7	D6	D5	D4	D3	D2	D1	D0	FUNCTION
0	1	1	1	1	0	0	0	26-dB gain, switching frequency set to 400 kHz , SpeakerGuard protection circuitry disabled
–	–	–	–	–	–	–	1	Switching frequency set to 500 khz
–	–	–	–	–	1	1	–	Reserved
–	–	1	1	0	–	–	–	SpeakerGuard protection circuitry set to 14-V peak output
–	–	1	0	1	–	–	–	SpeakerGuard protection circuitry set to 11.8-V peak output
–	–	1	0	0	–	–	–	SpeakerGuard protection circuitry set to 9.8-V peak output
–	–	0	1	1	–	–	–	SpeakerGuard protection circuitry set to 8.4-V peak output

Table 8. Control Register (0x03) (continued)

D7	D6	D5	D4	D3	D2	D1	D0	FUNCTION
–	–	0	1	0	–	–	–	SpeakerGuard protection circuitry set to 7-V peak output
–	–	0	0	1	–	–	–	SpeakerGuard protection circuitry set to 5.9-V peak output
–	–	0	0	0	–	–	–	SpeakerGuard protection circuitry set to 5-V peak output
0	0	–	–	–	–	–	–	Gain set to 20 dB
1	0	–	–	–	–	–	–	Gain set to 32 dB
1	1	–	–	–	–	–	–	Gain set to 36 dB

8 Application and Implementation

NOTE

Information in the following applications sections is not part of the TI component specification, and TI does not warrant its accuracy or completeness. TI's customers are responsible for determining suitability of components for their purposes. Customers should validate and test their design implementation to confirm system functionality.

8.1 Application Information

The device is a mono high-efficiency class-D audio amplifier. Typical use of the device is to amplify an audio input to drive a speaker. The intent of its use is for a bridge-tied load (BTL) application, not for support of single-ended configuration. This section presents how to use the device in the application, including what external components are necessary and how to connect unused pins.

8.2 Typical Application

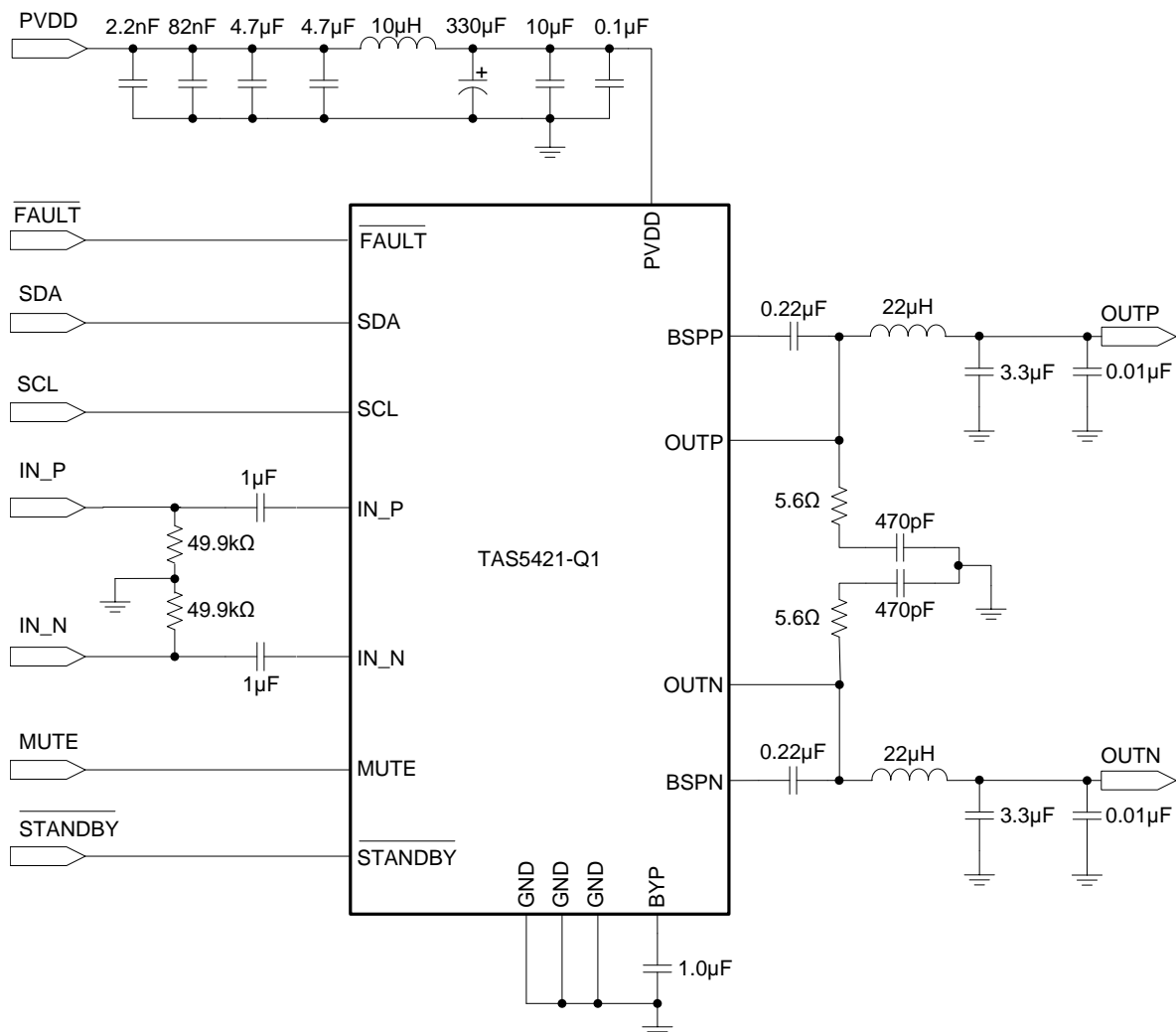

Figure 17. TAS5421-Q1 Typical Application Schematic

Typical Application (continued)

8.2.1 Design Requirements

Use the following for the design requirements:

- Power supplies
The device requires only a single power supply compliant with the recommended operation range. The device is designed to work with either a vehicle battery or regulated power supply such as from a backup battery.
- Communication
The device communicates with the system controller with both discrete hardware control pins and with I²C. The device is an I²C slave and thus requires a master. If a master I²C-compliant device is not present in the system, the device can still be used, but only with the default settings. Diagnostic information is limited to the discrete reporting $\overline{\text{FAULT}}$ pin.
- External components
[Table 9](#) lists the components required for the device.

Table 9. Supporting Components

EVM DESIGNATOR	QUANTITY	VALUE	SIZE	DESCRIPTION	USE IN APPLICATION
C7	1	10 $\mu\text{F} \pm 10\%$	1206	X7R ceramic capacitor, 25-V	Power supply
C8	1	330 $\mu\text{F} \pm 20\%$	10 mm	Low-ESR aluminum capacitor, 25-V	Power supply
C9, C16, C20	3	1 $\mu\text{F} \pm 10\%$	0805	X7R ceramic capacitor, 25-V	Analog audio input filter, bypass
C10, C14	2	0.22 $\mu\text{F} \pm 10\%$	0603	X7R ceramic capacitor, 25-V	Bootstrap capacitors
C11, C17	2	3.3 $\mu\text{F} \pm 10\%$	0805	X7R ceramic capacitor, 25-V	Amplifier output filtering
C13, C15	2	470 pF $\pm 10\%$	0603	X7R ceramic capacitor, 250-V	Amplifier output snubbers
C6	1	0.1 $\mu\text{F} \pm 10\%$	0603	X7R ceramic capacitor, 25-V	Power supply
C2	1	2200 pF $\pm 10\%$	0603	X7R ceramic capacitor, 50-V	Power supply
C3	1	0.082 $\mu\text{F} \pm 10\%$	0603	X7R ceramic capacitor, 25-V	Power supply
C4, C5	2	4.7 $\mu\text{F} \pm 10\%$	1206	X7R ceramic capacitor, 25-V	Power supply
C12, C18	2	0.01 $\mu\text{F} \pm 10\%$	0603	X7R ceramic capacitor, 25-V	Output EMI filtering
L1	1	10 $\mu\text{H} \pm 20\%$	13.5 mm x 13.5 mm	Shielded ferrite inductor	Power supply
L2	1	22 $\mu\text{H} \pm 20\%$	8 mm x 8 mm	Coupled inductor	Amplifier output filtering
R5, R6	2	49.9 k $\Omega \pm 1\%$	0805	Resistors, 0.125-W	Analog audio input filter
R4, R7	2	5.6 $\Omega \pm 5\%$	0805	Resistors, 0.125-W	Output snubbers

8.2.1.1 Amplifier Output Filtering

Output FETs drive the amplifier outputs in an H-bridge configuration. These transistors are either fully off or on. The result is a square-wave output signal with a duty cycle that is proportional to the amplitude of the audio signal. The amplifier outputs require a low-pass filter to filter out the PWM modulation carrier frequency. People frequently call this filter the L-C filter, due to the presence of an inductive element L and a capacitive element C to make up the 2-pole low-pass filter. The L-C filter attenuates the carrier frequency, reducing electromagnetic emissions and smoothing the current waveform which the load draws from the power supply. See [Class-D LC Filter Design](#) for a detailed description on proper component selection and design of an L-C filter based upon the desired load and response.

8.2.1.2 Amplifier Output Snubbers

A snubber is an RC network placed at the output of the amplifier to dampen ringing or overshoot on the PWM output waveform. Overshoot and ringing has several negative impacts including: potential EMI sources, degraded audio performance, and overvoltage stress of the output FETs or board components. For more information on the use and design of output snubbers, see [Class-D Output Snubber Design Guide](#).

8.2.1.3 Bootstrap Capacitors

The output stage uses dual NMOS transistors; therefore, the circuit requires bootstrap capacitors for the high side of each output to turn on correctly. The required capacitor connection is from BSTN to OUTN and from BSTP to OUTP as shown in [Figure 17](#).

8.2.1.4 Analog Audio Input Filter

The circuit requires an input capacitor to allow biasing of the amplifier put to the proper dc level. The input capacitor and the input impedance of the amplifier form a high-pass filter with a -3 -dB corner frequency determined by the equation: $f = 1 / (2\pi R_{(i)} C_{(i)})$, where $R_{(i)}$ is the input impedance of the device based on the gain setting and $C_{(i)}$ is the input capacitor value. [Table 10](#) lists largest recommended input capacitor values. Use a capacitor which matches the application requirement for the lowest frequency but does not exceed the values listed.

Table 10. Recommended Input AC-Coupling Capacitors

GAIN (dB)	TYPICAL INPUT IMPEDANCE (k Ω)	INPUT CAPACITANCE (μ F)	HIGH-PASS FILTER (Hz)
20	60	1	2.7
		1.5	1.8
26	30	1	5.3
		3.3	1.6
32	15	5.6	2.3
36	9	10	1.8

8.2.2 Detailed Design Procedure

Use the following steps for the design procedure:

- Step 1: Hardware Schematic Design: Using the [Figure 17](#) as a guide, integrate the hardware into the system schematic.
- Step 2: Following the layout guidelines recommended in the [Layout Guidelines](#) section, integrate the device and its supporting components into the system PCB file.
- Step 3: Thermal Design: The device has an exposed thermal pad which requires proper soldering. For more information, see [Semiconductor and IC Package Thermal Metrics](#) and [PowerPAD Thermally Enhanced Package](#).
- Step 4: Develop software: The EVM User's Guide has detailed instructions for how to set up the device, interpret diagnostic information, and so forth. For information about control registers, see the [Register Maps](#) section.
- For questions and support, go to the [E2E forums](#).

8.2.2.1 Unused Pin Connections

Even if unused, always connect pins to a fixed rail; do not leave them floating. Floating input pins represent an ESD risk, therefore the user must adhere to the following guidance for each pin.

8.2.2.1.1 MUTE Pin

If the MUTE pin is unused in the application, connect it to GND through a high-impedance resistor.

8.2.2.1.2 $\overline{\text{STANDBY}}$ Pin

If the $\overline{\text{STANDBY}}$ pin is unused in the application, connect it to a low-voltage rail such as 3.3 V or 5 V through a high-impedance resistor.

8.2.2.1.3 I²C Pins (SDA and SCL)

If there is no microcontroller in the system, use of the device without I²C communication is possible. In this situation, connect the SDA and SCL pins to 3.3 V.

8.2.2.1.4 Terminating Unused Outputs

If the $\overline{\text{FAULT}}$ pin does not report to a system microcontroller in the application, connect it to GND.

8.2.2.1.5 Using a Single-Ended Audio Input

When using a single-ended audio source, ac-ground the negative input through a capacitor equal in value to the input capacitor on the positive input, and apply the audio source to the positive input. For best performance, the ac ground should be at the audio source instead of at the device input if possible.

8.2.3 Application Curves

See the [Typical Characteristics](#) section for application performance plots.

Table 11. Table of Graphs

GRAPH	FIGURE NO.
Efficiency vs Output Power	Figure 3
THD+N vs Output Power	Figure 4
Output Power vs PVDD	Figure 5
THD+N vs Frequency	Figure 6
Noise FFT With –60-dB Output	Figure 7
Noise FFT With 1-W Output	Figure 8
Overcurrent Threshold vs Temperature	Figure 9

9 Power Supply Recommendations

A car battery that can have a large voltage range most commonly provides power for the device. PVDD, a filtered battery voltage, is the supply for the output FETs and the low-side FET gate driver. Good power-supply decoupling is necessary, especially at low voltage and temperature levels. To meet the PVDD specifications in the [Electrical Characteristics](#) section, TI uses 10- μ F and 0.1- μ F ceramic capacitors near the PVDD pin along with a larger bulk 330- μ F electrolytic decoupling capacitor.

An internal linear regulator, which powers the analog circuitry, provides the voltage on the BYP pin. This supply requires an external bypass ceramic capacitor at the BYP pin.

10 Layout

10.1 Layout Guidelines

The EVM layout optimizes for thermal dissipation and EMC performance. The TAS5421-Q1 device has a thermal pad down, and good thermal conduction and dissipation require adequate copper area. Layout also affects EMC performance. TAS5421Q1EVM illustrations form the basis for the layout discussions.

10.2 Layout Examples

10.2.1 Top Layer

The red boxes around number 1 are the copper ground on the top layer. Soldered directly to the thermal pad, the ground is the first significant thermal dissipation required. There are vias that go to the other layers for further thermal relief, but vias have high thermal resistance. TI recommends that use of the top layer be mostly for thermal dissipation. A further recommendation is short routes from output pins to the second-order LC filter for EMC suppression. The number 2 arrow indicates these short routes. The shorter the distance, the less EMC radiates. A short route from the PVDD pin to the LC filter from the battery or power source, as indicated by the number 3 arrow, also improves EMC suppression. The red box around number 4 indicates the ground plane that is common to both OUTP and OUTN. Place the capacitors of the LC filter in the common ground plane to help with common-mode noise and short ground loops.

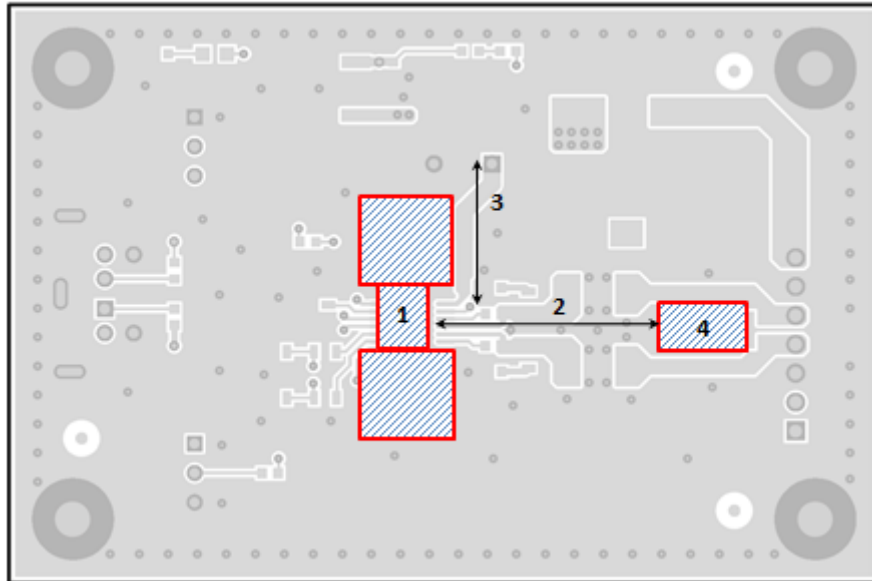
Layout Examples (continued)

Figure 18. Top Layer
10.2.2 Second Layer – Signal Layer

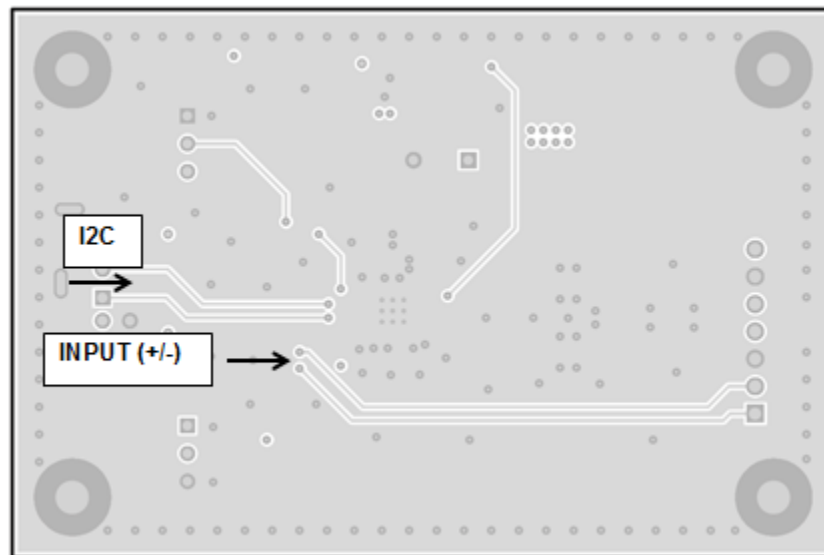
If possible, route the I²C and the positive and negative input traces close together and cover with ground plane, keeping the signals from noise.

Figure 19. Signal Layer

Layout Examples (continued)

10.2.3 Third Layer – Power Layer

There is no requirement for a power plane, but TI recommends a wide single PVDD trace to keep the switching noise to a minimum and provide enough current to the device. The wide trace provides a low-impedance path from the power source to the PVDD pin and from the GND pin to the source return. Suppression of switching noise (ripple voltage) on both the positive and return (ground) paths requires a low impedance.

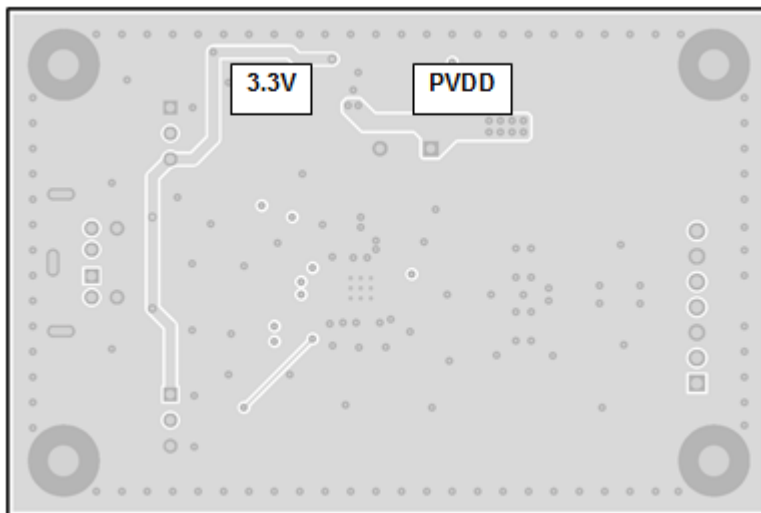

Figure 20. Power Layer

10.2.4 Bottom Layer – Ground Layer

The device has an exposed thermal pad on the bottom side for improved thermal performance. Conducting heat from the thermal pad to other layers requires thermal vias. Because the bottom layer is the secondary heat exchange surface to ambient, the thermal vias area must have low thermal resistance, that is, no signal vias or traces that can increase thermal resistance from the thermal vias to the bottom copper.

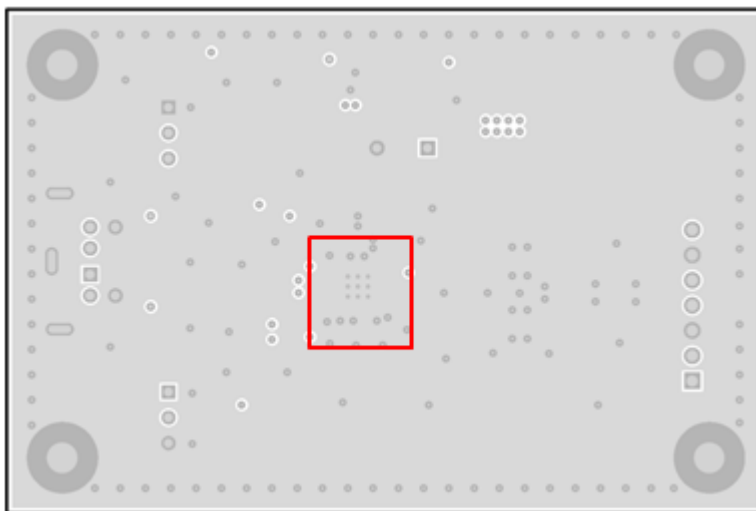

Figure 21. Bottom Layer

11 Device and Documentation Support

11.1 Device Support

11.1.1 Third-Party Products Disclaimer

TI'S PUBLICATION OF INFORMATION REGARDING THIRD-PARTY PRODUCTS OR SERVICES DOES NOT CONSTITUTE AN ENDORSEMENT REGARDING THE SUITABILITY OF SUCH PRODUCTS OR SERVICES OR A WARRANTY, REPRESENTATION OR ENDORSEMENT OF SUCH PRODUCTS OR SERVICES, EITHER ALONE OR IN COMBINATION WITH ANY TI PRODUCT OR SERVICE.

11.2 Documentation Support

11.2.1 Related Documentation

For related documentation see the following:

- [AN-1737 Managing EMI in Class D Audio Applications](#) (SNAA050)
- [AN-1849 An Audio Amplifier Power Supply Design](#) (SNAA057)
- [Class-D LC Filter Design](#) (SLOA119)
- [Class-D Output Snubber Design Guide](#) (SLOA201)
- [Filter-Free™ Class-D Audio Amplifiers](#) (SLOA145)
- [Guidelines for Measuring Audio Power Amplifier Performance](#) (SLOA068)
- [Power Rating in Audio Amplifiers](#) (SLEA047)
- [PowerPAD Thermally Enhanced Package](#) (SLMA002)
- [TAS5421EVM User's Guide](#) (SLOU365)

11.3 Receiving Notification of Documentation Updates

To receive notification of documentation updates, navigate to the device product folder on ti.com. In the upper right corner, click on *Alert me* to register and receive a weekly digest of any product information that has changed. For change details, review the revision history included in any revised document.

11.4 Community Resource

The following links connect to TI community resources. Linked contents are provided "AS IS" by the respective contributors. They do not constitute TI specifications and do not necessarily reflect TI's views; see TI's [Terms of Use](#).

TI E2E™ Online Community *TI's Engineer-to-Engineer (E2E) Community*. Created to foster collaboration among engineers. At e2e.ti.com, you can ask questions, share knowledge, explore ideas and help solve problems with fellow engineers.

Design Support *TI's Design Support* Quickly find helpful E2E forums along with design support tools and contact information for technical support.

11.5 Trademarks

PowerPAD, E2E are trademarks of Texas Instruments.
All other trademarks are the property of their respective owners.

11.6 Electrostatic Discharge Caution



This integrated circuit can be damaged by ESD. Texas Instruments recommends that all integrated circuits be handled with appropriate precautions. Failure to observe proper handling and installation procedures can cause damage.

ESD damage can range from subtle performance degradation to complete device failure. Precision integrated circuits may be more susceptible to damage because very small parametric changes could cause the device not to meet its published specifications.

11.7 Glossary

SLYZ022 — *TI Glossary*.

This glossary lists and explains terms, acronyms, and definitions.

12 Mechanical, Packaging, and Orderable Information

The following pages include mechanical packaging and orderable information. This information is the most-current data available for the designated devices. This data is subject to change without notice and without revision of this document. For browser-based versions of this data sheet, refer to the left-hand navigation.

PACKAGING INFORMATION

Orderable Device	Status (1)	Package Type	Package Drawing	Pins	Package Qty	Eco Plan (2)	Lead/Ball Finish (6)	MSL Peak Temp (3)	Op Temp (°C)	Device Marking (4/5)	Samples
TAS5421QPWPRQ1	ACTIVE	HTSSOP	PWP	16	2000	Green (RoHS & no Sb/Br)	CU NIPDAU	Level-3-260C-168 HR	-40 to 125	TAS5421	Samples

(1) The marketing status values are defined as follows:

ACTIVE: Product device recommended for new designs.

LIFEBUY: TI has announced that the device will be discontinued, and a lifetime-buy period is in effect.

NRND: Not recommended for new designs. Device is in production to support existing customers, but TI does not recommend using this part in a new design.

PREVIEW: Device has been announced but is not in production. Samples may or may not be available.

OBSOLETE: TI has discontinued the production of the device.

(2) Eco Plan - The planned eco-friendly classification: Pb-Free (RoHS), Pb-Free (RoHS Exempt), or Green (RoHS & no Sb/Br) - please check <http://www.ti.com/productcontent> for the latest availability information and additional product content details.

TBD: The Pb-Free/Green conversion plan has not been defined.

Pb-Free (RoHS): TI's terms "Lead-Free" or "Pb-Free" mean semiconductor products that are compatible with the current RoHS requirements for all 6 substances, including the requirement that lead not exceed 0.1% by weight in homogeneous materials. Where designed to be soldered at high temperatures, TI Pb-Free products are suitable for use in specified lead-free processes.

Pb-Free (RoHS Exempt): This component has a RoHS exemption for either 1) lead-based flip-chip solder bumps used between the die and package, or 2) lead-based die adhesive used between the die and leadframe. The component is otherwise considered Pb-Free (RoHS compatible) as defined above.

Green (RoHS & no Sb/Br): TI defines "Green" to mean Pb-Free (RoHS compatible), and free of Bromine (Br) and Antimony (Sb) based flame retardants (Br or Sb do not exceed 0.1% by weight in homogeneous material)

(3) MSL, Peak Temp. - The Moisture Sensitivity Level rating according to the JEDEC industry standard classifications, and peak solder temperature.

(4) There may be additional marking, which relates to the logo, the lot trace code information, or the environmental category on the device.

(5) Multiple Device Markings will be inside parentheses. Only one Device Marking contained in parentheses and separated by a "~" will appear on a device. If a line is indented then it is a continuation of the previous line and the two combined represent the entire Device Marking for that device.

(6) Lead/Ball Finish - Orderable Devices may have multiple material finish options. Finish options are separated by a vertical ruled line. Lead/Ball Finish values may wrap to two lines if the finish value exceeds the maximum column width.

Important Information and Disclaimer: The information provided on this page represents TI's knowledge and belief as of the date that it is provided. TI bases its knowledge and belief on information provided by third parties, and makes no representation or warranty as to the accuracy of such information. Efforts are underway to better integrate information from third parties. TI has taken and continues to take reasonable steps to provide representative and accurate information but may not have conducted destructive testing or chemical analysis on incoming materials and chemicals. TI and TI suppliers consider certain information to be proprietary, and thus CAS numbers and other limited information may not be available for release.

In no event shall TI's liability arising out of such information exceed the total purchase price of the TI part(s) at issue in this document sold by TI to Customer on an annual basis.

TAPE AND REEL INFORMATION



QUADRANT ASSIGNMENTS FOR PIN 1 ORIENTATION IN TAPE



*All dimensions are nominal

Device	Package Type	Package Drawing	Pins	SPQ	Reel Diameter (mm)	Reel Width W1 (mm)	A0 (mm)	B0 (mm)	K0 (mm)	P1 (mm)	W (mm)	Pin1 Quadrant
TAS5421QPWPRQ1	HTSSOP	PWP	16	2000	330.0	12.4	6.9	5.6	1.6	8.0	12.0	Q1

TAPE AND REEL BOX DIMENSIONS



*All dimensions are nominal

Device	Package Type	Package Drawing	Pins	SPQ	Length (mm)	Width (mm)	Height (mm)
TAS5421QPWRQ1	HTSSOP	PWP	16	2000	350.0	350.0	43.0

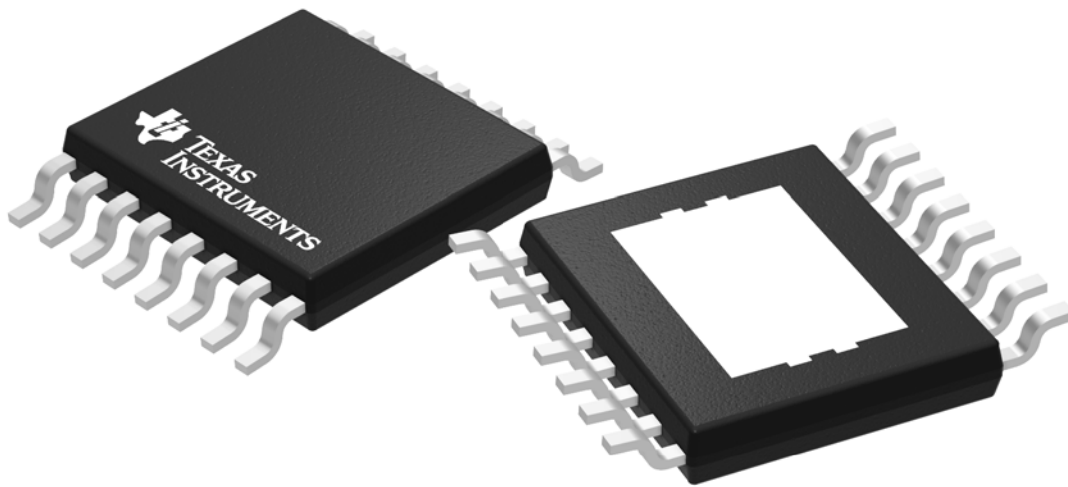

Images above are just a representation of the package family, actual package may vary.
Refer to the product data sheet for package details.

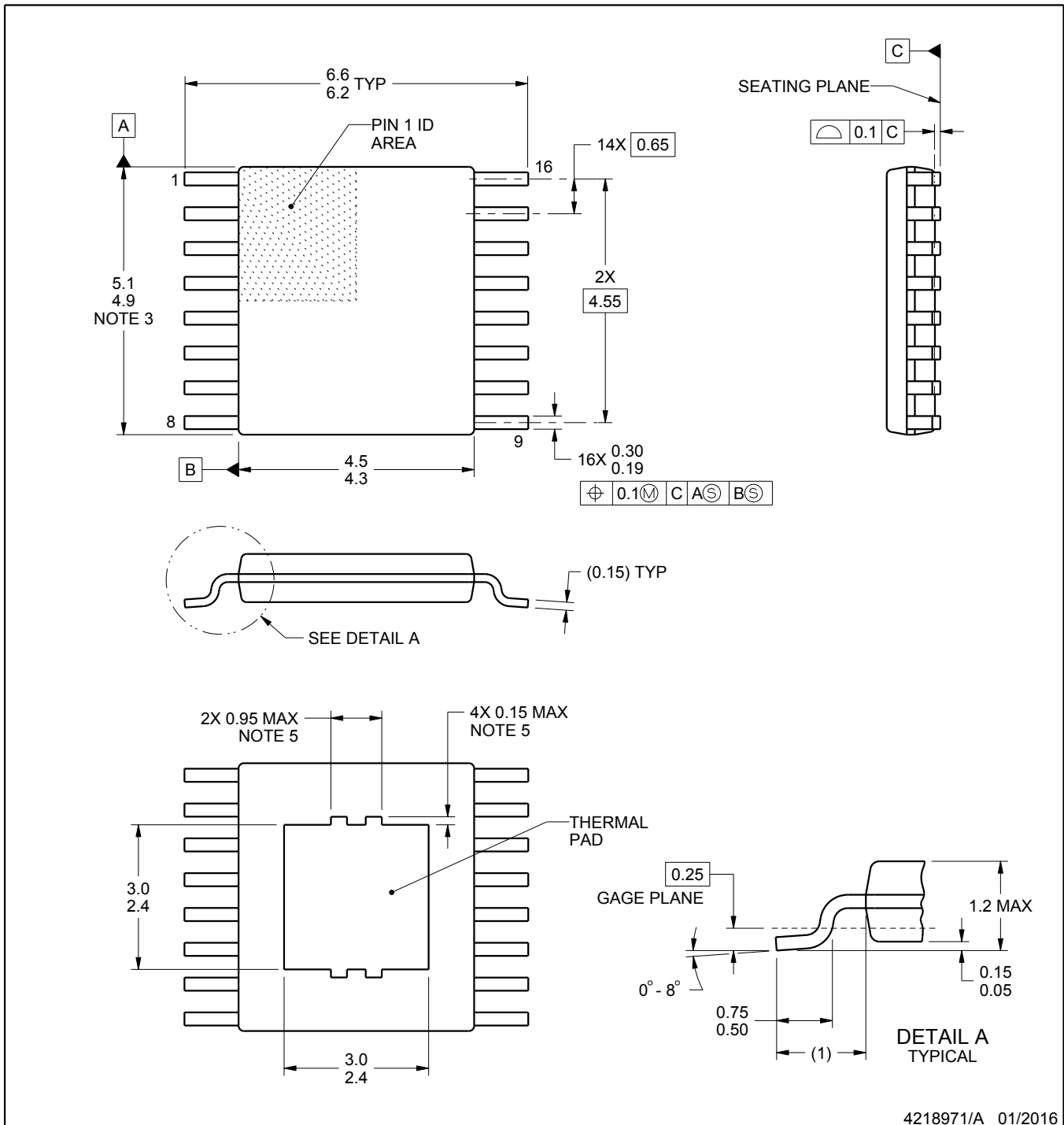
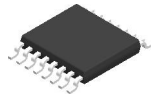

4218971/A 01/2016

NOTES:

PowerPAD is a trademark of Texas Instruments.

1. All linear dimensions are in millimeters. Any dimensions in parenthesis are for reference only. Dimensioning and tolerancing per ASME Y14.5M.
2. This drawing is subject to change without notice.
3. This dimension does not include mold flash, protrusions, or gate burrs. Mold flash, protrusions, or gate burrs shall not exceed 0.15 mm per side.
4. Reference JEDEC registration MO-153.
5. Features may not be present.

EXAMPLE BOARD LAYOUT

PWP0016B

PowerPAD™ TSSOP - 1.2 mm max height

PLASTIC SMALL OUTLINE

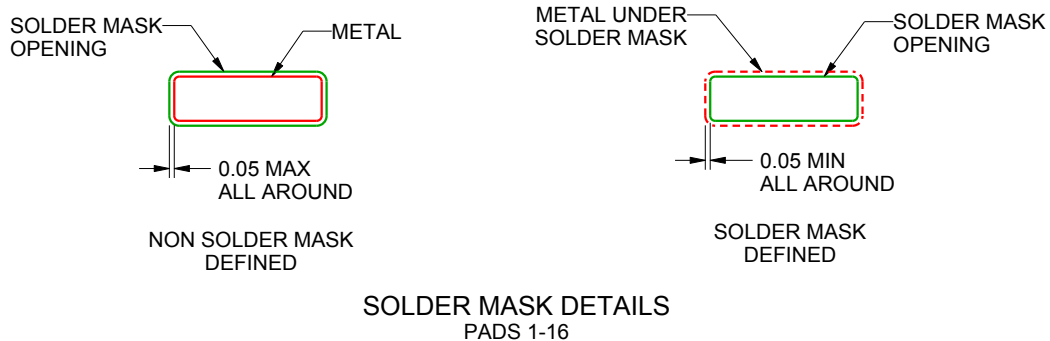
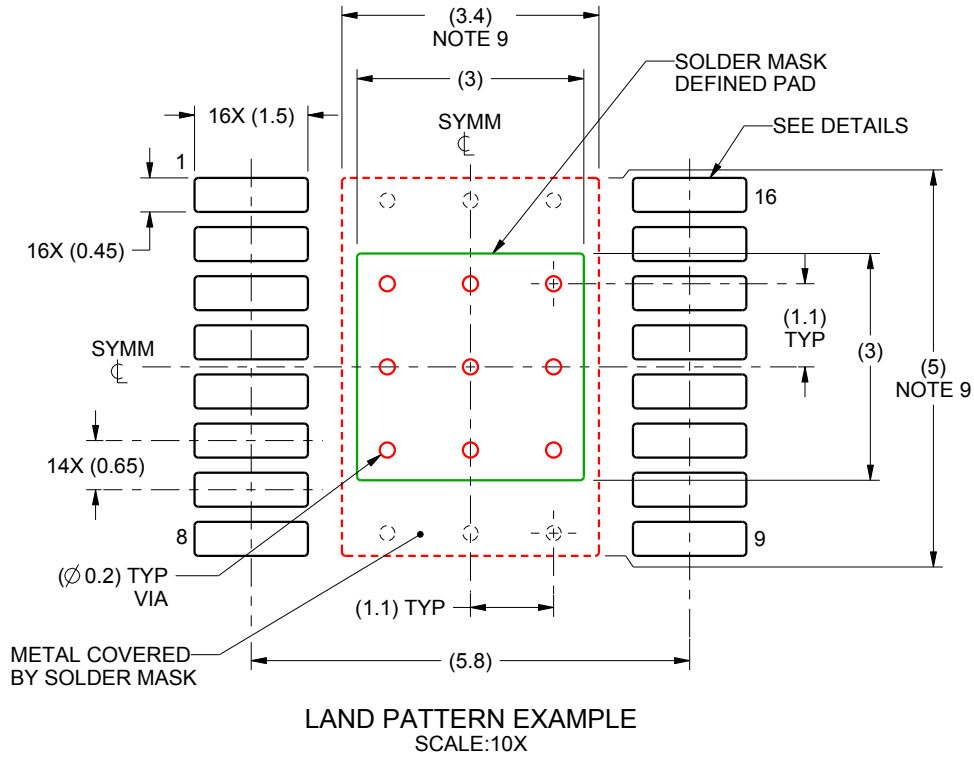

4218971/A 01/2016

NOTES: (continued)

6. Publication IPC-7351 may have alternate designs.
7. Solder mask tolerances between and around signal pads can vary based on board fabrication site.
8. This package is designed to be soldered to a thermal pad on the board. For more information, see Texas Instruments literature numbers SLMA002 (www.ti.com/lit/slma002) and SLMA004 (www.ti.com/lit/slma004).
9. Size of metal pad may vary due to creepage requirement.

EXAMPLE STENCIL DESIGN

PWP0016B

PowerPAD™ TSSOP - 1.2 mm max height

PLASTIC SMALL OUTLINE

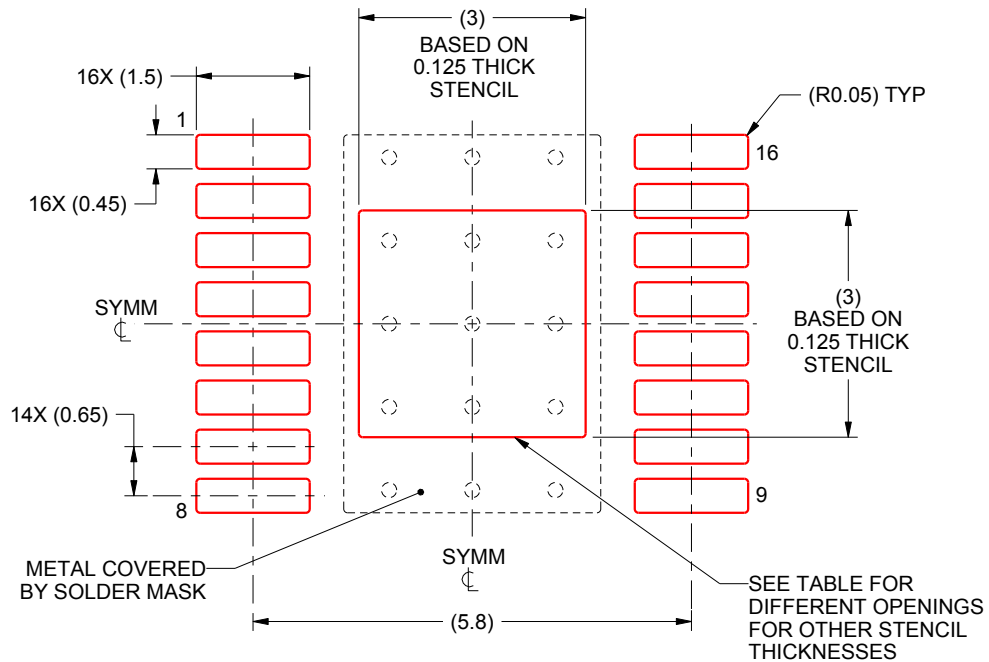

SOLDER PASTE EXAMPLE
 EXPOSED PAD
 100% PRINTED SOLDER COVERAGE BY AREA
 SCALE:10X

STENCIL THICKNESS	SOLDER STENCIL OPENING
0.1	3.35 X 3.35
0.125	3 X 3 (SHOWN)
0.15	2.74 X 2.74
0.175	2.54 X 2.54

4218971/A 01/2016

NOTES: (continued)

- 10. Laser cutting apertures with trapezoidal walls and rounded corners may offer better paste release. IPC-7525 may have alternate design recommendations.
- 11. Board assembly site may have different recommendations for stencil design.

IMPORTANT NOTICE AND DISCLAIMER

TI PROVIDES TECHNICAL AND RELIABILITY DATA (INCLUDING DATASHEETS), DESIGN RESOURCES (INCLUDING REFERENCE DESIGNS), APPLICATION OR OTHER DESIGN ADVICE, WEB TOOLS, SAFETY INFORMATION, AND OTHER RESOURCES "AS IS" AND WITH ALL FAULTS, AND DISCLAIMS ALL WARRANTIES, EXPRESS AND IMPLIED, INCLUDING WITHOUT LIMITATION ANY IMPLIED WARRANTIES OF MERCHANTABILITY, FITNESS FOR A PARTICULAR PURPOSE OR NON-INFRINGEMENT OF THIRD PARTY INTELLECTUAL PROPERTY RIGHTS.

These resources are intended for skilled developers designing with TI products. You are solely responsible for (1) selecting the appropriate TI products for your application, (2) designing, validating and testing your application, and (3) ensuring your application meets applicable standards, and any other safety, security, or other requirements. These resources are subject to change without notice. TI grants you permission to use these resources only for development of an application that uses the TI products described in the resource. Other reproduction and display of these resources is prohibited. No license is granted to any other TI intellectual property right or to any third party intellectual property right. TI disclaims responsibility for, and you will fully indemnify TI and its representatives against, any claims, damages, costs, losses, and liabilities arising out of your use of these resources.

TI's products are provided subject to TI's Terms of Sale (www.ti.com/legal/termsofsale.html) or other applicable terms available either on ti.com or provided in conjunction with such TI products. TI's provision of these resources does not expand or otherwise alter TI's applicable warranties or warranty disclaimers for TI products.

Mailing Address: Texas Instruments, Post Office Box 655303, Dallas, Texas 75265
Copyright © 2019, Texas Instruments Incorporated