

Proximity sensing module

Datasheet - production data

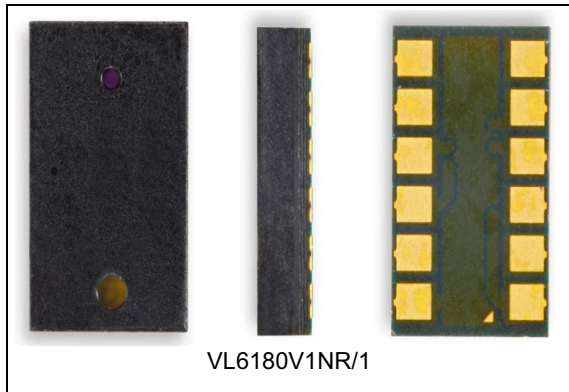

Features

- Two-in-one smart optical module
 - VCSEL light source
 - Proximity sensor
- Fast, accurate distance ranging
 - Measures absolute range from 0 to 62 cm max (depending on conditions)
 - Independent of object reflectance
 - Ambient light rejection
 - Cross-talk compensation for cover glass
- Gesture recognition
 - Distance and signal level can be used by host system to implement gesture recognition
 - Demo systems (implemented on Android smartphone platform) available.
- Easy integration
 - Single reflowable component
 - No additional optics
 - Single power supply
 - I²C interface for device control and data
 - Provided with a documented C portable API (Application Programming Interface)
- Two programmable GPIO
 - Window and thresholding functions for ranging

Applications

- Laser Assisted Auto Focus
- Smartphones/portable touchscreen devices
- Tablet/laptop/gaming devices
- Domestic appliances/industrial devices

Description

The VL6180 is the latest product based on ST's patented **FlightSense™** technology. This is a ground-breaking technology allowing absolute distance to be measured independent of target reflectance. Instead of estimating the distance by measuring the amount of light reflected back from the object (which is significantly influenced by color and surface), the VL6180 precisely measures the time the light takes to travel to the nearest object and reflect back to the sensor (Time-of-Flight).

Combining an IR emitter and a range sensor in a two-in-one ready-to-use reflowable package, the VL6180 is easy to integrate and saves the end-product maker long and costly optical and mechanical design optimizations.

The module is designed for low power operation. Ranging measurements can be automatically performed at user defined intervals. Multiple threshold and interrupt schemes are supported to minimize host operations.

Host control and result reading is performed using an I²C interface. Optional additional functions, such as measurement ready and threshold interrupts, are provided by two programmable GPIO pins.

A complete API is also associated with the device which consists of a set of C functions controlling the VL6180 to enable fast development of end-user applications. This API is structured in a way that it can be compiled on any kind of platform through a well isolated platform layer (mainly for low level I2C access).

Contents

- 1 Overview 8**
 - 1.1 Technical specification 8
 - 1.2 System block diagram 8
 - 1.3 Device pinout 9
 - 1.4 Typical application schematic 10
 - 1.5 Recommended solder pad dimensions 10
 - 1.6 Recommended reflow profile 11

- 2 Functional description 12**
 - 2.1 Ranging 12
 - 2.2 System state diagram 12
 - 2.3 Timing diagram 14
 - 2.4 Software 15
 - 2.5 Operating modes 16
 - 2.5.1 Polling mode - single shot measurement 16
 - 2.5.2 Interrupt mode - continuous measurement 17
 - 2.5.3 Asynchronous mode - single shot measurement 18
 - 2.6 Range timing 19
 - 2.7 Range error codes 20
 - 2.8 Range checks 21
 - 2.8.1 Early convergence estimate (ECE) 21
 - 2.8.2 Range ignore 22
 - 2.8.3 Signal-to-noise ratio (SNR) 22
 - 2.9 Manual/autoVHV calibration 23
 - 2.10 History buffer 23
 - 2.11 Wrap Around Filter 24
 - 2.12 Scaling 24
 - 2.13 Maximum ranging distance (Dmax) 25
 - 2.14 Current consumption 25
 - 2.14.1 Ranging current consumption 25
 - 2.14.2 Current consumption calculator 26
 - 2.14.3 Current distribution 27

2.15	Other system considerations	28
2.15.1	Part-to-part range offset	28
2.15.2	Cross-talk	28
2.15.3	Offset calibration procedure	29
2.15.4	Cross-talk calibration procedure	29
2.15.5	Cross-talk limit	30
2.15.6	Cross-talk vs air gap	30
3	Ranging specification	31
3.1	Proximity ranging (0 to 100mm)	31
3.1.1	Max range vs. ambient light level	31
3.2	Extended range (>100mm)	32
3.2.1	Extended range conditions	32
3.2.2	Max range vs. ambient light level	32
4	I²C control interface	34
4.1	I ² C interface - timing characteristics	36
5	Electrical characteristics	37
5.1	Absolute maximum ratings	37
5.2	Normal operating conditions	37
5.3	Electrical characteristics	38
6	Device registers	39
6.1	Register encoding formats	39
6.2	Register descriptions	42
6.2.1	IDENTIFICATION__MODEL_ID	42
6.2.2	IDENTIFICATION__MODEL_REV_MAJOR	42
6.2.3	IDENTIFICATION__MODEL_REV_MINOR	42
6.2.4	IDENTIFICATION__MODULE_REV_MAJOR	43
6.2.5	IDENTIFICATION__MODULE_REV_MINOR	43
6.2.6	IDENTIFICATION__DATE_HI	43
6.2.7	IDENTIFICATION__DATE_LO	44
6.2.8	IDENTIFICATION__TIME	44
6.2.9	SYSTEM__MODE_GPIO0	45
6.2.10	SYSTEM__MODE_GPIO1	46

6.2.11	SYSTEM__HISTORY_CTRL	47
6.2.12	SYSTEM__INTERRUPT_CONFIG_GPIO	48
6.2.13	SYSTEM__INTERRUPT_CLEAR	48
6.2.14	SYSTEM__FRESH_OUT_OF_RESET	48
6.2.15	SYSTEM__GROUPED_PARAMETER_HOLD	49
6.2.16	SYSRANGE__START	49
6.2.17	SYSRANGE__THRESH_HIGH	50
6.2.18	SYSRANGE__THRESH_LOW	51
6.2.19	SYSRANGE__INTERMEASUREMENT_PERIOD	51
6.2.20	SYSRANGE__MAX_CONVERGENCE_TIME	51
6.2.21	SYSRANGE__CROSSTALK_COMPENSATION_RATE	52
6.2.22	SYSRANGE__CROSSTALK_VALID_HEIGHT	52
6.2.23	SYSRANGE__EARLY_CONVERGENCE_ESTIMATE	52
6.2.24	SYSRANGE__PART_TO_PART_RANGE_OFFSET	53
6.2.25	SYSRANGE__RANGE_IGNORE_VALID_HEIGHT	53
6.2.26	SYSRANGE__RANGE_IGNORE_THRESHOLD	53
6.2.27	SYSRANGE__MAX_AMBIENT_LEVEL_MULT	54
6.2.28	SYSRANGE__RANGE_CHECK_ENABLES	54
6.2.29	SYSRANGE__VHV_RECALIBRATE	55
6.2.30	SYSRANGE__VHV_REPEAT_RATE	55
6.2.31	RESULT__RANGE_STATUS	56
6.2.32	RESULT__INTERRUPT_STATUS_GPIO	57
6.2.33	RESULT__HISTORY_BUFFER_x	57
6.2.34	RESULT__RANGE_VAL	58
6.2.35	RESULT__RANGE_RAW	58
6.2.36	RESULT__RANGE_RETURN_RATE	59
6.2.37	RESULT__RANGE_REFERENCE_RATE	60
6.2.38	RESULT__RANGE_RETURN_SIGNAL_COUNT	60
6.2.39	RESULT__RANGE_REFERENCE_SIGNAL_COUNT	61
6.2.40	RESULT__RANGE_RETURN_AMB_COUNT	61
6.2.41	RESULT__RANGE_REFERENCE_AMB_COUNT	61
6.2.42	RESULT__RANGE_RETURN_CONV_TIME	62
6.2.43	RESULT__RANGE_REFERENCE_CONV_TIME	62
6.2.44	READOUT__AVERAGING_SAMPLE_PERIOD	62
6.2.45	FIRMWARE__BOOTUP	63
6.2.46	I2C_SLAVE__DEVICE_ADDRESS	63

7	Outline drawing	64
8	Laser safety considerations	66
	8.1 Compliance	66
9	Ordering information	67
	9.1 Traceability and identification	67
	9.2 Part marking	67
	9.3 Packaging	68
	9.3.1 Package labeling	68
	9.4 Storage	69
	9.5 ROHS Compliance	69
10	ECOPACK®	70
11	Revision history	71

List of tables

Table 1.	Technical specification	8
Table 2.	VL6180 pin numbers and signal descriptions	9
Table 3.	Recommended reflow profile	11
Table 4.	Power-up timing constraints	14
Table 5.	VL6180 operating modes	16
Table 6.	Continuous mode limits (10 Hz operation)	18
Table 7.	Typical range convergence time (ms)	20
Table 8.	Range error codes	20
Table 9.	History buffer	24
Table 10.	Typical current consumption in different operating states	25
Table 11.	Breakdown of current consumption	26
Table 12.	Average current consumption on AVDD and AVDD_VCSEL	27
Table 13.	Ranging specification 0 to 100mm	31
Table 14.	Worst case max range vs. ambient 0 to 100mm	31
Table 15.	Worst case max range vs. ambient >100mm	33
Table 16.	Range limits for a 400 mm target @ ambient rate 2.1Mcps	33
Table 17.	Worst case achievable light levels	33
Table 18.	I ² C interface - timing characteristics	36
Table 19.	Absolute maximum ratings	37
Table 20.	Normal operating conditions	37
Table 21.	Digital I/O electrical characteristics	38
Table 22.	Register groups	39
Table 23.	32-bit register example	39
Table 24.	Register formats	39
Table 25.	Register summary	40
Table 26.	Delivery format	67
Table 27.	Storage conditions	69
Table 28.	Document revision history	71

List of figures

Figure 1.	VL6180 block diagram	8
Figure 2.	VL6180 pinout	9
Figure 3.	VL6180 schematic	10
Figure 4.	Recommended solder pattern	10
Figure 5.	Recommended reflow profile	11
Figure 6.	Ranging pipe architecture	12
Figure 7.	System state diagram	13
Figure 8.	Power-up timing	14
Figure 9.	Simple range routine	15
Figure 10.	Polling mode	17
Figure 11.	Interrupt mode	17
Figure 12.	Asynchronous mode	19
Figure 13.	Total range execution time	20
Figure 14.	ECE	22
Figure 15.	Wrap around	24
Figure 16.	Typical ranging current consumption (10 Hz sampling rate)	26
Figure 17.	VCSEL pulse duty cycle	27
Figure 18.	Part-to-part range offset	28
Figure 19.	Cross-talk compensation	28
Figure 20.	Cross-talk vs air gap	30
Figure 21.	Typical ranging performance	32
Figure 22.	Serial interface data transfer protocol	34
Figure 23.	I2C device address	34
Figure 24.	Single location, single write	34
Figure 25.	Single location, single read	35
Figure 26.	Multiple location write	35
Figure 27.	Multiple location read	35
Figure 28.	I ² C timing characteristics	36
Figure 29.	Outline drawing - module - VL6180V1NR/1 - (page 1/2)	64
Figure 30.	Outline drawing - module - VL6180V1NR/1 - (page 2/2)	65
Figure 31.	Class 1 laser product label	66
Figure 32.	Part marking	67
Figure 33.	Tape and reel packaging	68
Figure 34.	Package labeling	68

1 Overview

This datasheet is applicable to the final VL6180 ROM code revision.

1.1 Technical specification

Table 1. Technical specification

Feature	Detail
Package	Optical LGA12
Size	4.8 x 2.8 x 1.0 mm
Ranging	0 to 62 ⁽¹⁾ cm maximum
Functional operating voltage	2.6 to 3.0 V
Typical power consumption	Hardware standby (GPIO0 = 0): < 1 uA ⁽²⁾ Software standby: < 1uA ⁽²⁾ Ranging: 1.7 mA (typical average) ⁽³⁾
Functional operating temperature	-20 to 70°C
IR emitter	850 nm
I ² C	400 kHz serial bus Address: 0x29 (7-bit)

1. Maximum distance dependent on target reflectance and external conditions (ambient light level, temperature, voltage).
2. GPIO0, GPIO1, SCL and SDA are pulled up to AVDD (2.8V)
3. Assumes 10 Hz sampling rate, 17% reflective target at 50 mm

1.2 System block diagram

Figure 1. VL6180 block diagram

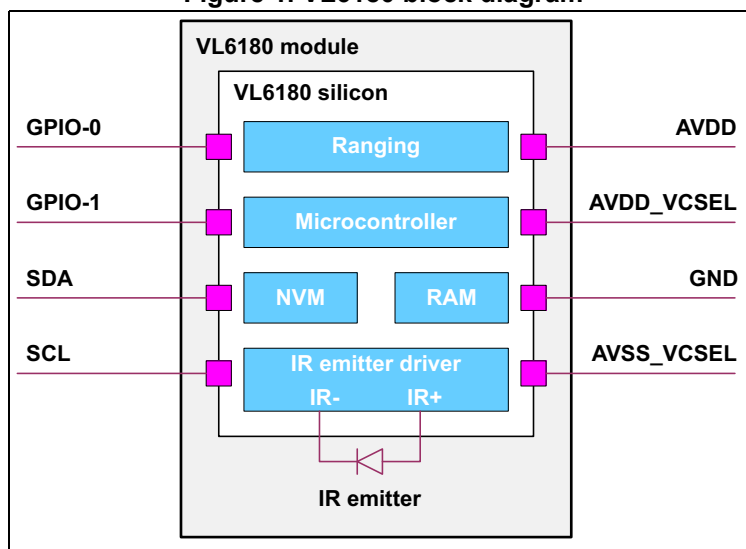

1.3 Device pinout

Figure 2 shows the pinout of the VL6180.

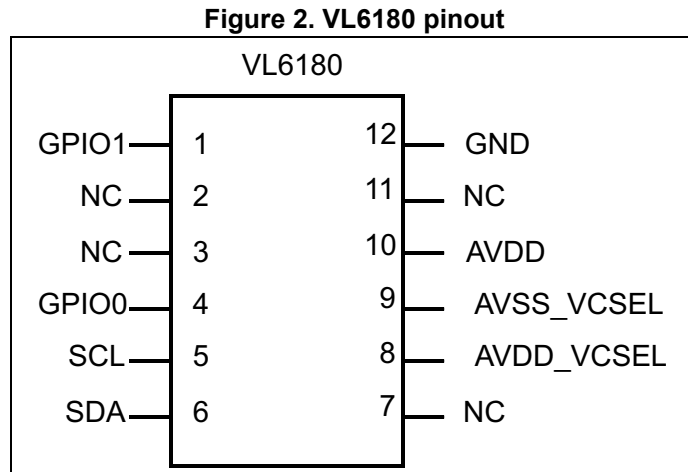

Table 2. VL6180 pin numbers and signal descriptions

Pin number	Signal name	Signal type	Signal description
1	GPIO1	Digital I/O	Interrupt output. Open-drain. If used, it should be pulled high with 47 k Ω resistor, otherwise left unconnected.
2	NC		No connect
3	NC		No connect
4	GPIO0/CE	Digital I/O	Power-up default is chip enable (CE). It should be pulled high with a 47 k Ω resistor.
5	SCL	Digital input	I ² C serial clock
6	SDA	Digital I/O	I ² C serial data
7	NC		No connect
8	AVDD_VCSEL	Supply	VCSEL power supply. 2.6 to 3.0 V
9	AVSS_VCSEL	Ground	VCSEL ground
10	AVDD	Supply	Digital/analog power supply. 2.6 to 3.0 V
11	NC		No connect
12	GND	Ground	Digital/analog ground

1.4 Typical application schematic

Figure 3 shows the typical application schematic of the VL6180.

Figure 3. VL6180 schematic

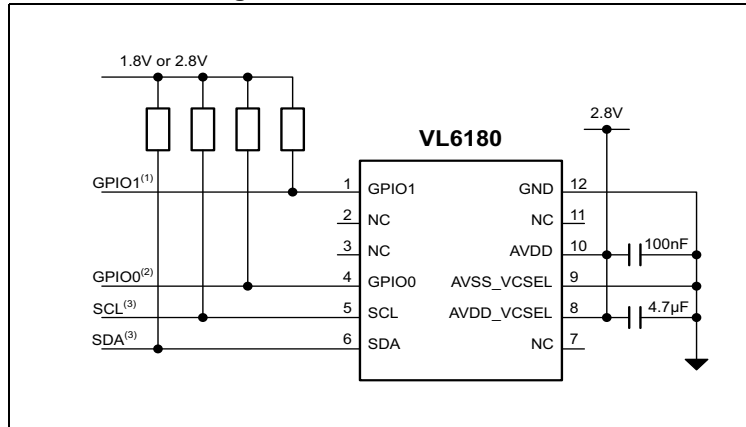

- 1. Open drain. If pin is used, then 47kΩ recommended, otherwise leave floating
- 2. Open drain. 47kΩ recommended
- 3. Open drain. Pull up resistors typically fitted once per I²C bus at host

Note: Capacitors on AVDD and AVDD_VCSEL should be placed as close as possible to the supply pads.

1.5 Recommended solder pad dimensions

Figure 4. Recommended solder pattern

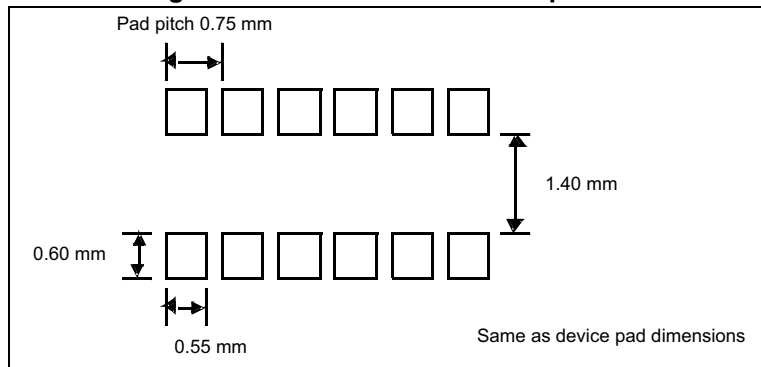

1.6 Recommended reflow profile

The recommend reflow profile is shown in [Figure 5](#) and [Table 3](#).

Figure 5. Recommended reflow profile

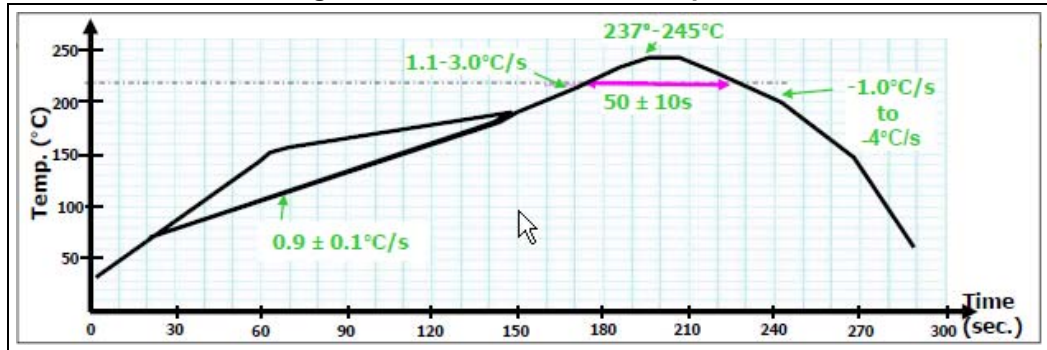

Table 3. Recommended reflow profile

Profile	Ramp to strike	
Temperature gradient in preheat	(T= 70 - 180°C):	0.9 +/- 0.1°C/s
Temperature gradient	(T= 200 - 225°C):	1.1 - 3.0°C/s
Peak temperature in reflow	237°C - 245°C	
Time above 220°C	50 +/- 10 seconds	
Temperature gradient in cooling	-1 to -4 °C/s (-6°C/s maximum)	
Time from 50 to 220°C	160 to 220 seconds	

Note: As the VL6180 package is not sealed, only a dry re-flow process should be used (such as convection re-flow). Vapor phase re-flow is not suitable for this type of optical component.

The VL6180 is an optical component and as such, it should be treated carefully. This would typically include using a 'no-wash' assembly process.

2 Functional description

It is assumed in the rest of the document that the host application is controlling the VL6180 device through its C API.

For a more detailed explanation of the API functions please refer to the documentation that is supplied with the API.

The API is available on request from ST.

2.1 Ranging

The VL6180 uses a simple pipe architecture to achieve range measurement.

Figure 6. Ranging pipe architecture

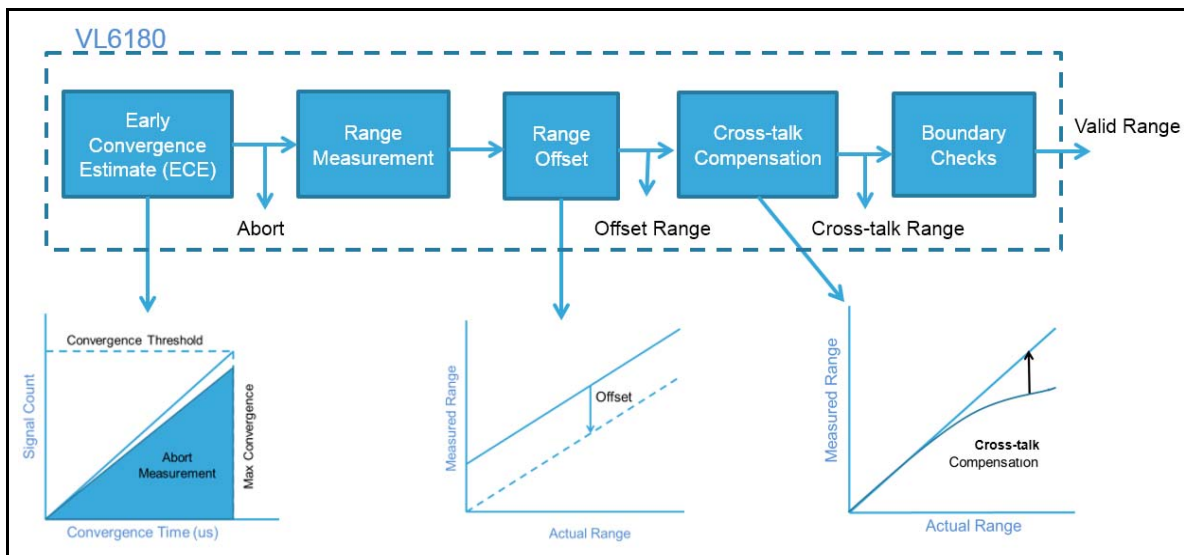

2.2 System state diagram

Figure 7 describes the main operating states of the VL6180. Hardware standby is the reset state (GPIO0=0)^(a). The device is held in reset until GPIO0 is de-asserted. Note that the device will not respond to I²C communication in this mode. When GPIO0=1, the device enters software standby after the internal MCU boot sequence has completed.

a. Use of GPIO0 is optional

From a customer application point of view, the following sequence must be followed at the power-up stage

- Set GPIO0 to 0
- Set GPIO0 to 1
- Wait for a minimum of 400us
- Call **VL6180x_WaitDeviceBooted()**^(b) API function (or wait 1ms to ensure device is ready).

Then, at this stage, it is possible to configure the device and start single-shot or continuous ranging operation through API functions calls.

Figure 7. System state diagram

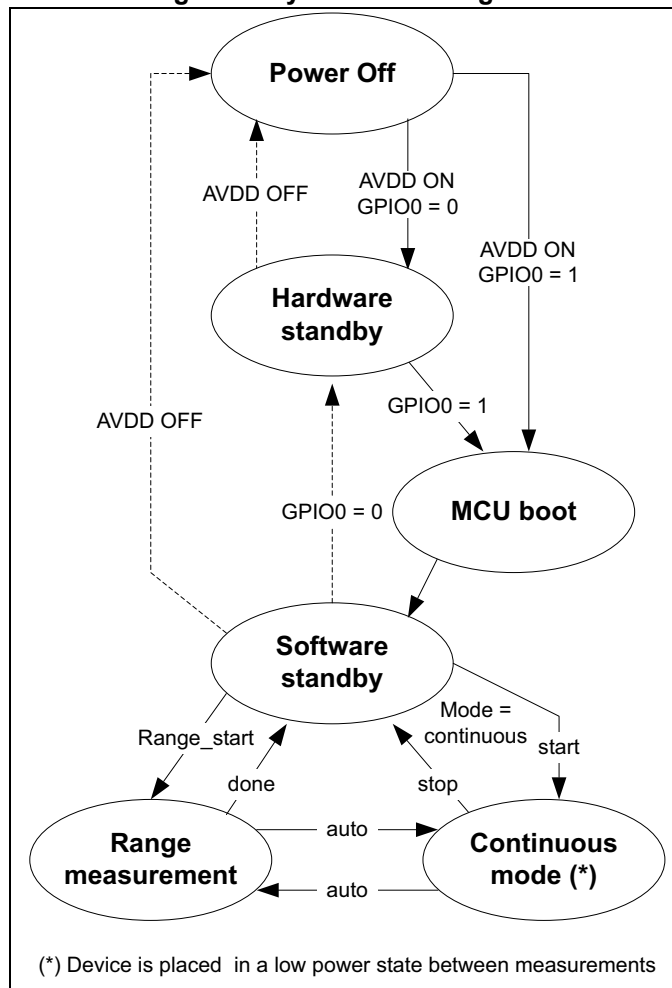

b. Warning: The **VL6180x_WaitDeviceBooted()** function expects the device to be fresh out of reset. Calling this function when the device is not fresh out of rest will result in an infinite loop.

2.3 Timing diagram

Figure 8 and Table 4 show the VL6180 power-up timing constraints.

- AVDD_VCSEL must be applied before or at the same time as AVDD.
- GPIO0 defaults to an active low shutdown input. When GPIO0 = 0, the device is in hardware standby. If GPIO0 is not used it should be connected to AVDD.
- The internal microprocessor (MCU) boot sequence commences when AVDD is up and GPIO0 is high whichever is the later.
- GPIO1 power-up default is output low. It is tri-stated during the MCU boot sequence.

Note: In hardware standby, GPIO1 is output low and will sink current through any pull-up resistor. This leakage can be minimized by increasing the value of the pull-up resistor.

- After the MCU boot sequence the device enters software standby. Host initialization can commence immediately after entering software standby.

Figure 8. Power-up timing

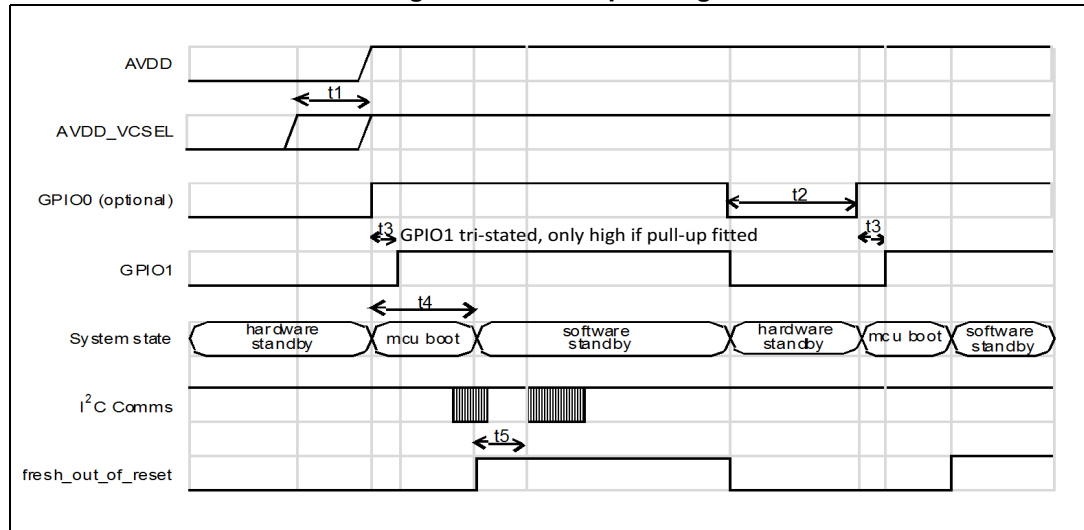

Table 4. Power-up timing constraints

Symbol	Parameter	Min	Max	Unit
t1	AVDD_VCSEL power applied after AVDD	-	0	ms
t2	Minimum reset on GPIO0	100	-	ns
t3	GPIO1 output low after hardware standby	-	400	µs
t4	MCU boot	-	1	ms
t5	Software standby to host initialization	-	0	ms

2.4 Software

Figure 9 shows a simple start-up routine from initialization to completing a range measurement (ignoring offset and cross-talk calibration). The polling function is a very simple function, but would not be used in the final application as it is a blocking function.

Figure 9. Simple range routine

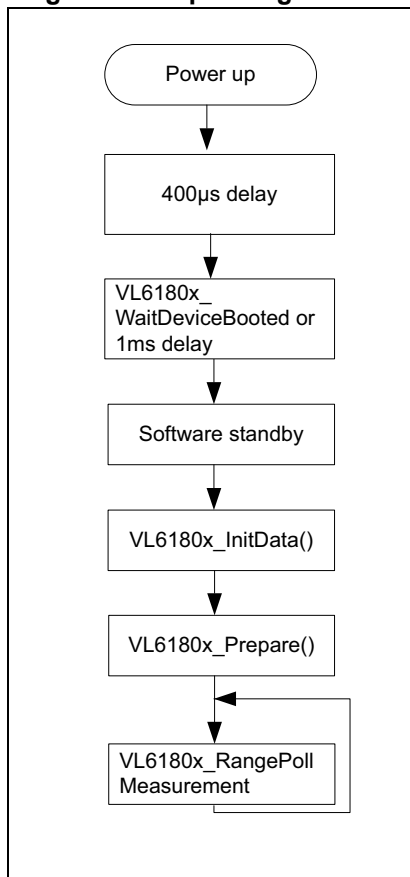

2.5 Operating modes

The VL6180 device can operate in 2 different range modes:

Single-shot measurement or Continuous measurement.

From these 2 device modes, the VL6180 API enables 3 different typical operating modes:

Polling, interrupt or asynchronous.

Note: Wrap Around Filter is not available in Continuous measurement mode.

Table 5. VL6180 operating modes

API operating mode	Description	API functions	VL6180 mode	Comments
Polling	Host requests single shot measurement and waits for the result	VL6180x_RangePollMeasurement	Single shot	Recommended for first API porting or debug
Interrupt	Ranging results are retrieved from interrupts	VL6180x_RangeSetInterMeasPeriod VL6180x_SetupGPIO1 VL6180x_RangeConfigInterrupt (VL6180x_RangeSetThreshold) VL6180x_RangeStartContinuousMode VL6180x_RangeGetMeasurement VL6180x_ClearAllInterrupt	Continuous	Recommended for User Detection applications where CPU is interrupted by VL6180 so can be asleep when no target is detected (power saving)
Asynchronous	Host requests a single shot measurement and regularly checks to see if result is ready or not	VL6180x_RangeStartSingleShot VL6180x_RangeGetMeasurement IfReady	Single shot	Recommended for AF-Assist applications, Android OS-based system where CPU is synchronized by EOF/SOF from camera or by a timer so that top application controls measurement periods

2.5.1 Polling mode - single shot measurement

Host calls a blocking API function that requests a single shot measurement and waits for the result. CPU is blocked during ranging.

Figure 10. Polling mode

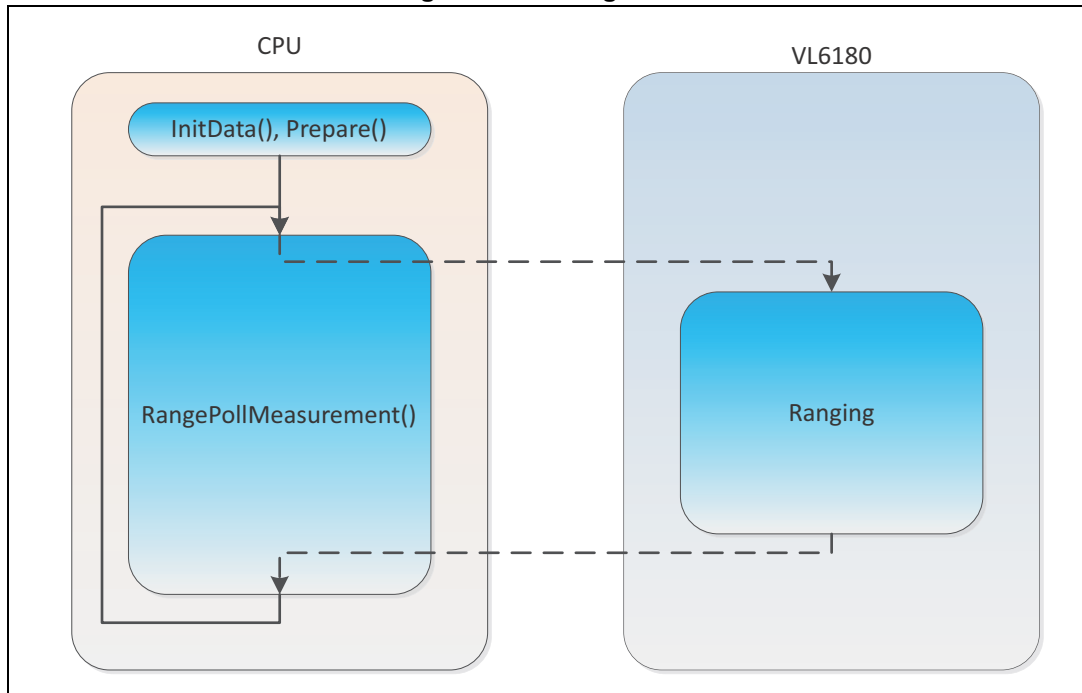

2.5.2 Interrupt mode - continuous measurement

Host programs the device in continuous mode and ranging results are retrieved from interrupts.

Figure 11. Interrupt mode

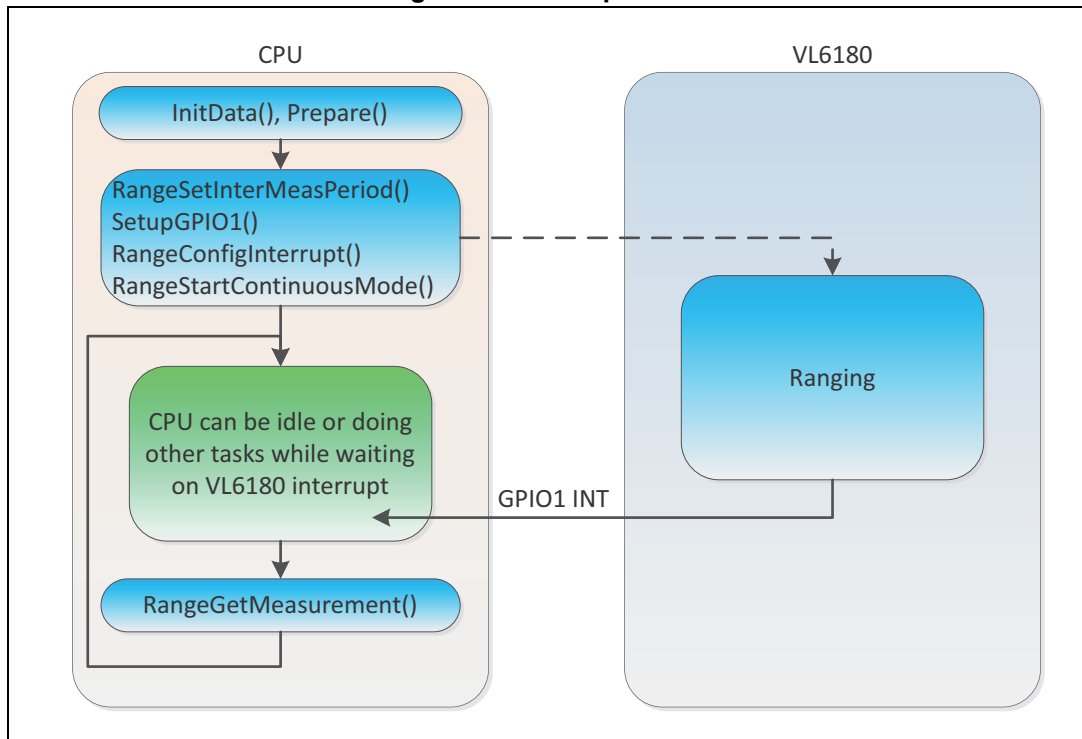

VL6180x_RangeConfigInterrupt()

The VL6180 can be configured to generate a range interrupt flag under any of the following conditions:

- New sample ready
- Level low (range value < low threshold)
- Level high (range value > high threshold)
- Out of window (range value < low threshold) OR (range value > high threshold)

In new sample ready mode, an interrupt flag will be raised at the end of every measurement irrespective of whether the measurement is valid or if an error has occurred. This mode is particularly useful during development and debug.

In level interrupt mode the system will raise an interrupt flag if either a low or high programmable threshold has been crossed.

Out of window interrupt mode activates both high and low level thresholds allowing a window of operation to be specified.

Range interrupt modes are selected via **VL6180x_RangeConfigInterrupt()** with **VL6180x_RangeSetThresholds()** used to set thresholds. Use **VL6180x_RangeGetInterruptStatus()** to return the ranging interrupt status.

Note: In level or window interrupt modes range errors will only trigger an interrupt if the logical conditions described above are met.

Continuous mode limits

To take account of oscillator tolerances and internal processing overheads it is necessary to place the following constraints on continuous mode operations. The following equations define the minimum inter-measurement period to ensure correct operation:

Continuous range:

$$VL6180x_RangeSetMaxConvergenceTime() + 5 \leq VL6180x_RangeSetInterMeasPeriod() * 0.9$$

Table 6. gives an example how to apply these limits in continuous mode operating at a sampling rate of 10 Hz.

Table 6. Continuous mode limits (10 Hz operation)

Parameter	Period (ms)
VL6180x_RangeSetMaxConvergenceTime()	30
Total RANGE EXECUTION TIME	35

2.5.3 Asynchronous mode - single shot measurement

Host requests a single shot measurement and can either check regularly to see if result is ready or wait for an interrupt then call **RangeGetMeasurementIfReady()**.

Figure 12. Asynchronous mode

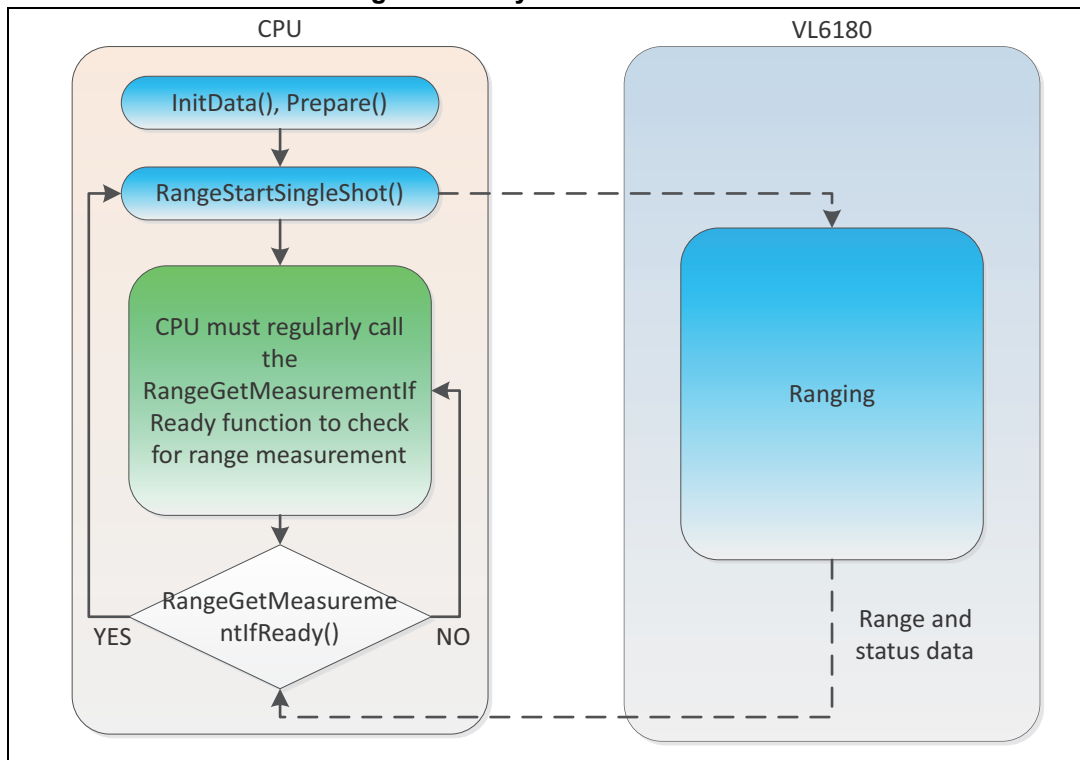

2.6 Range timing

Figure 13 gives a breakdown of total execution time for a single range measurement.

- The pre-calibration phase is fixed (3.2 ms).
- The range convergence time is variable and depends on target distance/reflectance (see Table 7).
- The recommended readout averaging period is 4.3 ms. Readout averaging helps to reduce measurement noise. The recommended setting for `READOUT__AVERAGING_SAMPLE_PERIOD{0x10A}` is 48^(c) but is programmable in the range 0-255. Note however that lower settings will result in increased noise.

Register `READOUT__AVERAGING_SAMPLE_PERIOD{0x10A}` is not programmable via the API.

Note: When a target is detected the API returns the actual range convergence time. The convergence time returned by the API does not include the readout average. Range convergence and readout averaging must be completed within the specified max convergence time.

VL6180x_RangeSetMaxConvergenceTime() - sets maximum time to run measurement in all ranging modes. Range = 1 - 63 ms; measurement aborted when limit reached. Effective max convergence time depends on the actual convergence time plus readout averaging sample period setting.

c. Default readout averaging period is calculated as follows: $1300 \mu\text{s} + (48 \times 64.5 \mu\text{s}) = 4.3 \text{ ms}$

Figure 13. Total range execution time

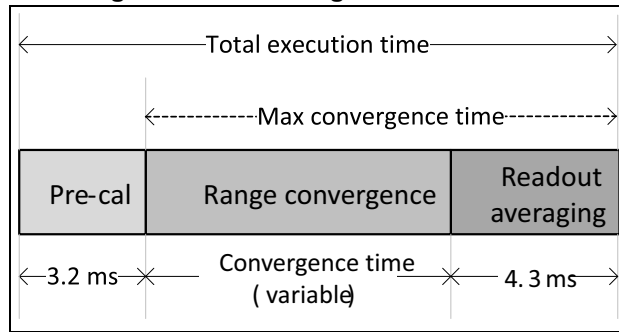

Table 7. Typical range convergence time (ms)

Range (mm)	Target reflectance			
	3%	5%	17%	88%
10	0.43	0.33	0.18	0.18
20	0.94	0.73	0.28	0.18
30	1.89	1.40	0.51	0.18
40	3.07	2.25	0.81	0.18
50	4.35	3.24	1.18	0.24
60	5.70	4.22	1.60	0.32
70	7.07	5.35	2.07	0.49
80	8.41	6.45	2.58	0.50
90	9.58	7.56	3.14	0.61
100	10.73	8.65	3.69	0.73

2.7 Range error codes

Before using a measurement returned with a range API function, the application must first check that the function call has succeeded (returned 0) and then check the **Range.errorStatus** for possible error codes.

[Table 8](#) gives a summary of the error codes. Calling `VL6180x_RangeGetStatusErrString()` will also return the error code/description.

Table 8. Range error codes

Bits [7:4]	Error code	Description
0	No error	Valid measurement
1-5	System error	System error detected (can only happen on power on). No measurement possible.
6	Early convergence estimate	ECE check failed
7	Max convergence	System did not converge before the specified max. convergence time limit
8	Range ignore	Ignore threshold check failed

Table 8. Range error codes (continued)

Bits [7:4]	Error code	Description
9-10	Not used	-
11	Signal to Noise Ratio	Ambient conditions too high. Measurement not valid
12/14	Range underflow	Range value < 0 If the target is very close (0-10mm) and the offset is not correctly calibrated it could lead to a small negative value
13/15	Range overflow	Range value out of range. This occurs when the target is detected by the device but is placed at a high distance resulting in internal variable overflow. Proximity ranging, target > 200mm (scaling = 1) Extended ranging, target > 550mm (scaling = 3)
16	Ranging_Filtered	Distance filtered by Wrap Around Filter (WAF). Occurs when a high reflectance target is detected between 600mm to 1.2m
17	Not used	-
18	Data_Not_Ready	Error returned by VL6180x_RangeGetMeasurementIfReady() when ranging data is not ready

2.8 Range checks

Error codes 6, 8 & 11 in [Table 8](#) are configurable by the user (SNR, error 11, has not yet been integrated into the API).

2.8.1 Early convergence estimate (ECE)

Note: *Early convergence estimate (ECE) is not used, by default, in extended ranging mode.*

Early convergence estimate (ECE) is a programmable feature designed to minimize power consumption when there is no target in the field-of-view (FOV).

The system is said to have 'converged' (i.e. range acquired), when the convergence threshold^(d) is reached before the max. convergence time limit (see [Figure 14](#)). This ratio specifies the minimum return signal rate required for convergence. If there is no target in the FOV, the system will continue to operate until the max. convergence time limit is reached before switching off thereby consuming power. With ECE enabled, the system estimates the return signal rate 0.5 ms after the start of every measurement. If it is below the ECE threshold, the measurement is aborted and an ECE error is flagged.

d. For proximity ranging, the convergence threshold is set to 10240. The convergence threshold register is not accessible by the user.

Figure 14. ECE

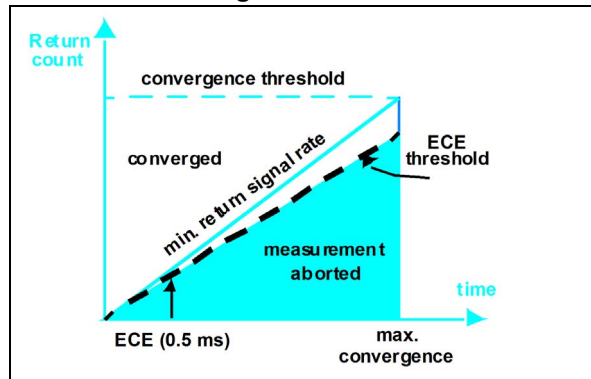

ECE is enabled by setting **VL6180x_RangeSetEceState()** and configured with **VL6180x_RangeSetEceFactor()**. This allows the user to change the ECE threshold from the default of 15% below minimum convergence rate. As shown by the example below.

$$\text{ECE threshold} = \frac{85\% \times 0.5 \times 10240}{\text{Max convergence time (in ms)}}$$

If the max convergence time is set to 30 ms (using **VL6180x_RangeSetMaxConvergenceTime()**), then the ECE threshold is 196. That is, if the return count is less than 196 after 0.5 ms, the measurement will be aborted.

Note: The optimum value for the ECE threshold should be determined in the final application.

2.8.2 Range ignore

In a system with cover glass, the return signal from the glass (cross-talk) may be sufficient to cause the system to converge and return a valid range measurement even when there is no target present. The range ignore feature is designed to ensure that the system does not range on the glass. (Cross-talk is described in more detail in [Section 2.15.2](#)).

The ignore threshold is enabled with **VL6180x_RangeIgnoreSetEnable()**. If enabled, the ignore threshold and valid height must be specified, this is set with **VL6180x_RangeIgnoreConfigure()**.

A range ignore error will be flagged if the return signal rate is less than the ignore threshold.

Note: The optimum value for the ignore threshold and valid height should be determined in the final application.

2.8.3 Signal-to-noise ratio (SNR)

SNR function not yet implemented in API.

In high ambient conditions range accuracy can be impaired so the SNR threshold is used as a safety limit to invalidate range measurements where the ambient/signal ratio is considered too high. The default ambient/signal ratio limit is 10 (i.e. an SNR of 0.1) which is then encoded in 4.4 format as follows:

$$\text{SYSRANGE_MAX_AMBIENT_LEVEL_MULT}\{0x2C\} = 10 \times 16 = 160$$

To enable the SNR check, set bit 4 in `SYSRANGE__RANGE_CHECK_ENABLES` (0x02D). A lower setting results in a more aggressive filter which will result in a lower effective range but greater accuracy. A higher setting results in a less aggressive filter which will result in a greater effective range but lower accuracy.

The SNR value can be calculated as follows:

$$\text{SNR} = \frac{\text{RESULT_RANGE_RETURN_SIGNAL_COUNT}\{0x6C\}}{\text{RESULT_RANGE_RETURN_AMB_COUNT}\{0x74\} * 6}$$

Note: The SNR value is the inverse of the ambient/signal ratio limit {0x2C}.

Note: The optimum value for SNR threshold should be determined in the final application.

2.9 Manual/autoVHV calibration

Manual/auto VHV not yet implemented in API.

SPAD^(e) sensitivity is temperature dependent so VHV^(f) calibration is used to regulate SPAD sensitivity over temperature in order to minimize signal rate variation. VHV calibration is performed either manually by the host processor or automatically by internal firmware. Execution time is typically 200 μs so has no impact on normal operation.

A VHV calibration is run once at power-up and then automatically after every N range measurements defined by the `SYSRANGE__VHV_REPEAT_RATE`{0x31} register. AutoVHV calibration is disabled by setting this register to 0. Default is 255. If autoVHV is disabled it is recommended to run a manual VHV calibration periodically to recalibrate for any significant temperature variation. A manual VHV calibration is performed by setting `SYSRANGE__VHV_RECALBRATE`{0x2E} to 1. This register auto-clears. This operation should only be performed in software standby.

2.10 History buffer

History buffer not yet implemented in API.

The history buffer is a 8 x 16-bit memory which can be used to store the last 16 range measurements (8-bit). Use of the history buffer is controlled via register `SYSTEM__HISTORY_CTRL`{0x12}. There are 3 basic functions:

- enable
- range selection
- clear buffer

The buffer is read via eight 16-bit registers (`RESULT__HISTORY_BUFFER_0`{0x52} to `RESULT__HISTORY_BUFFER_7`{0x60}). The buffer holds the last 16 x 8-bit range results as shown in [Table 9](#).

e. Photon detectors - Single Photon Avalanche Diodes

f. VHV is an adjustable SPAD bias voltage and stands for Very High Voltage (typically around 14 V). Also sometimes referred to as CP (Charge Pump).

Table 9. History buffer

History buffer	Range	
	(High byte)	(Low byte)
0	Range [15] (newest)	Range [14]
1	Range [13]	Range [12]
2	Range [11]	Range [10]
3	Range [9]	Range [8]
4	Range [7]	Range [6]
5	Range [5]	Range [4]
6	Range [3]	Range [2]
7	Range [1]	Range [0] (oldest)

Note: Only one data stream can be buffered at one time. There is no associated time stamp information.

The clear buffer command is not immediate; it takes effect on the next range start command.

The history buffer works independently of interrupt control i.e. the history buffer records all new samples; its operation is unchanged in threshold and window modes.

2.11 Wrap Around Filter

Wrap-around is an effect linked to the ratio between the VCSEL pulse period and the photon return pulse.

Figure 15. Wrap around

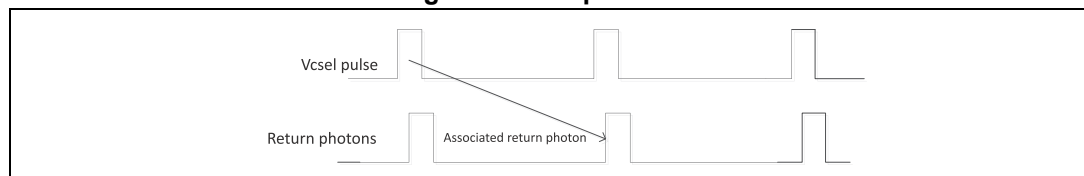

High reflective targets (like mirrors) placed at a far distance (>600mm) from the VL6180 can still produce enough return signal for the VL6180 to declare a valid target and meet the wrap-around condition resulting in a wrong (under-estimated) returned distance.

The WAF implemented in the API is able to automatically detect if a target is in the wrap-around condition and filter it by returning an invalid distance (**Range.errorStatus = 16**). The WAF is enabled/disabled via **VL6180x_FilterSetState()** and read with **VL6180x_FilterGetState()**.

2.12 Scaling

The default scaling factor is 3, which allows for maximum ranging capabilities. The scaling factor can be decreased to x2 or x1 for short range applications.

Note: With a scaling factor of 2/3, the reported range minimum resolution also increases to 2/3mm.

VL6180x_UpscaleSetScaling() is a single API function which allows the user to change the scaling factor of the device. **VL6180x_UpscaleGetScaling()** can be used to read the scaling factor.

Scaling factor = 1 = proximity ranging (up to ~20 cm)

Scaling factor = 1 = proximity ranging (up to ~40 cm)

Scaling factor = 3 = extended ranging (up to ~60 cm)

2.13 Maximum ranging distance (Dmax)

A target placed in front of the VL6180 device may not be detected because it is too far away for the given ambient light conditions.

When ambient light level increases, max detection range (Dmax) decreases

When no target is detected (no valid distance), the VL6180 API is able to estimate Dmax as the maximum distance up to which a 17% target would have been detected with the current ambient light level.

When no target is detected by the VL6180, the application can interpret the Dmax value as no target is detected and there is no 17% (or above) target between 0 and Dmax mm.

DMAX is enabled/disabled by **VL6180x_DMaxSetState()** and read with **VL6180x_DMaxGetState()**.

Note: Dmax is estimated for a 17% reflectance target. If the real target has a lower reflectance, then the Dmax calculated by the API could be overestimated.

2.14 Current consumption

[Table 10](#) gives an overview of current consumption in different operating states.

Table 10. Typical current consumption in different operating states

Mode	Current	Conditions
Hardware standby	< 1 μ A	Shutdown (GPIO0 = 0). No I ² C comms
Software standby	< 1 μ A	After MCU boot. Device ready
Ranging	1.7 mA	Average consumption during ranging ⁽¹⁾

1. 10 Hz sampling rate, 17% reflective target at 50 mm.

2.14.1 Ranging current consumption

[Figure 16](#) shows typical ranging current consumption of the VL6180. Current consumption depends on target distance, target reflectance and sampling rate. The example shown here is based on default settings and a sampling rate of 10 Hz. The average current consumption for a 17% reflective target at 50 mm operating at 10 Hz is 1.7 mA. At different sampling rates the current consumption scales accordingly i.e. the average current consumption at 1 Hz under the same conditions would be 0.17 mA.

Figure 16. Typical ranging current consumption (10 Hz sampling rate)

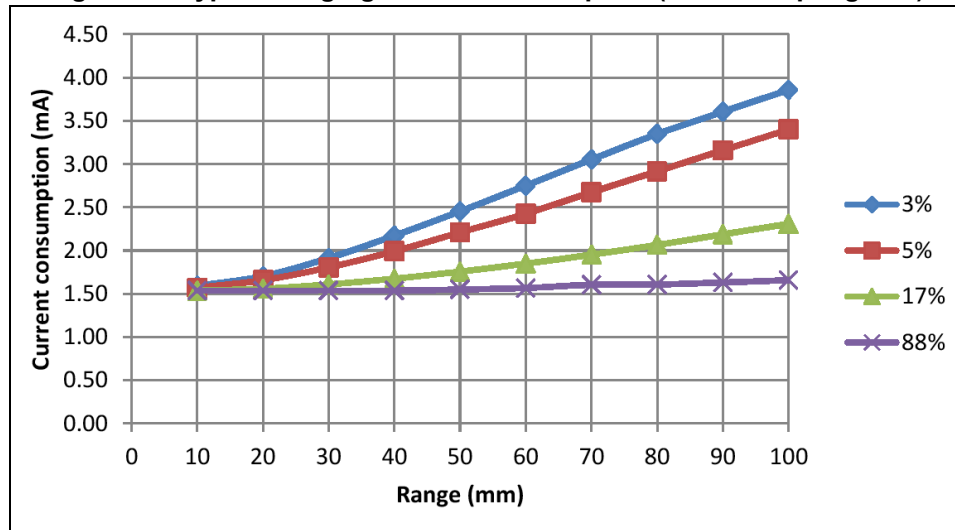

The minimum average current consumption in [Figure 16](#). is 1.5 mA, 0.5 mA of which comes from pre-calibration before each measurement and 1.0 mA from post-processing (readout averaging). Pre-calibration is a fixed overhead but readout averaging can be reduced or effectively disabled by setting the `READOUT__AVERAGING_SAMPLE_PERIOD{0x10A}` to zero (default setting is 48).

Note: Decreasing the `READOUT__AVERAGING_SAMPLE_PERIOD` will increase sampling noise. It is recommended that any change in setting be properly evaluated in the end application.

Minimum current consumption scales with sampling rate i.e. at a sampling rate of 1 Hz the current consumption associated with pre- and post-processing will be 0.15 mA.

2.14.2 Current consumption calculator

[Table 11](#). gives a breakdown of typical current consumption for pre-calibration, ranging and readout averaging.

Table 11. Breakdown of current consumption

Label	Phase	I (mA)	t (ms)	Q (μC) = I x t
Q ₁	Pre-calibration	13.0	3.2	41.6
Q ₂	Ranging	22.0	per ms	22.0 per ms
Q ₃	Readout averaging	25.0	per ms	25.0 per ms

Current consumption can then be calculated as follows:

$$I (\mu A) = \text{sampling_rate} * [Q_1 + (Q_2 * \text{RESULT_RANGE_RETURN_CONV_TIME in ms}) + Q_3 * (1.3 + (\text{READOUT_AVERAGING_SAMPLE_PERIOD} * 0.0645 \text{ ms}))]$$

[Table 7](#). gives typical convergence times for different target reflectance.

So, for example, `RESULT__RANGE_RETURN_CONV_TIME` for a 3% target at 50 mm is 4.35 ms. At 10 Hz sampling rate this gives:

$$I (\mu A) = 10 * [41.6 + (22 * 4.35) + 25 * (1.3 + (48 * 0.0645))] = 2472 \mu A$$

2.14.3 Current distribution

Table 12. shows how current consumption is distributed between the two supplies in ranging mode. AVDD_VCSEL supplies the VCSEL current and AVDD supplies all other functions.

Angle of divergent laser emission is 25° +/- 5°.

The condition of divergent angle of 25° laser emission is 1/e² of the peak intensity.

Note: The VCSEL driver is pulsed at 100 MHz with a 33% duty cycle (see *Figure 17.*) so average current consumption on AVDD_VCSEL is one third of the peak.

Table 12. Average current consumption on AVDD and AVDD_VCSEL

Power supply ⁽¹⁾	Current	Note
AVDD	14 mA	Average during active ranging
AVDD_VCSEL	8 mA ⁽²⁾	Average during active ranging (33% duty cycle).

1. Normally, both supplies will be driven from a common source giving a peak instantaneous current demand of 38 mA.

2. Peak emitter current during ranging is 24 mA. Peak power is 14mW.

Figure 17. VCSEL pulse duty cycle

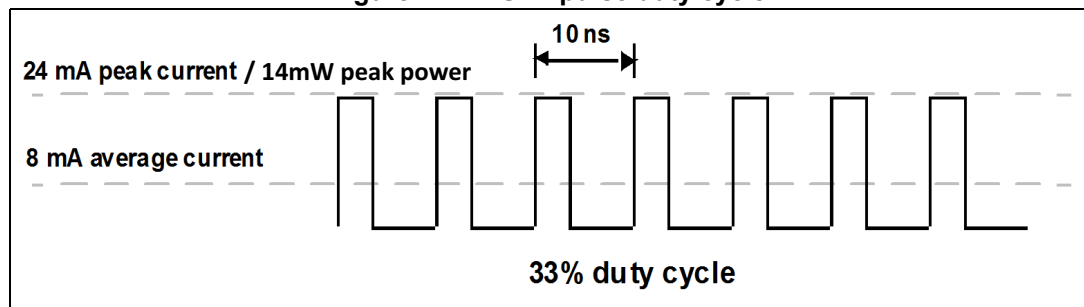

2.15 Other system considerations

This section describes part-to-part range offset and system cross-talk. In addition, a procedure for cross-talk calibration is given.

2.15.1 Part-to-part range offset

The VL6180 is factory calibrated to produce an absolute linear range output as shown in [Figure 18](#). The part-to-part range offset is calibrated during manufacture and stored in NVM. Use `VL6180x_GetOffsetCalibrationData()` to read offset from NVM (after `VL6180x_InitData()`). The API always returns the range with the part-to-part offset already applied.

Figure 18. Part-to-part range offset

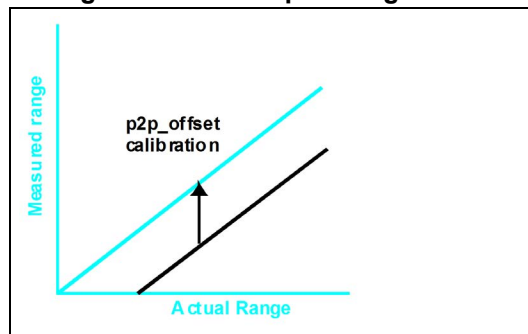

2.15.2 Cross-talk

Cross-talk is defined as the signal return from the cover glass. The magnitude of the cross-talk depends on the type of glass, air gap and filter material. Cross-talk results in a range error (see [Figure 19](#)) which is proportional to the ratio of the cross-talk to the signal return from the target. The true range is recovered by applying automatic cross-talk compensation.

Figure 19. Cross-talk compensation

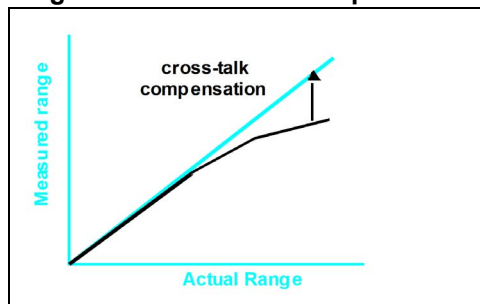

Cross-talk compensation is enabled by using `VL6180x_SetXTalkCompensationRate()`. A cross-talk calibration procedure is described in [Section 2.15.4](#).

2.15.3 Offset calibration procedure

Complete steps 1-4 to see if part-to-part offset calibration is required.

1. Read scaling factor **VL6180x_UpscaleGetScaling()**, turn off WAF
VL6180x_FilterSetState() = 0, turn off range ignore features
VL6180x_RangeIgnoreSetEnable() = 0 and clear all interrupts
VL6180x_ClearAllInterrupt().
2. Position a white target (88% reflectance^(g)) at a distance of 50mm (scaling factor 1) or 100 mm (scaling factor 2/3) from the top of the cover glass.
3. Perform a minimum of 10 range measurements and compute the average range using **VL6180x_RangePollMeasurement()**.
4. If the average range is within target distance ± 3 mm, offset calibration is not required. Otherwise, complete the calibration procedure.
5. Set **VL6180x_SetOffsetCalibrationData()** = 0.
6. Perform a minimum of 10 range measurements and compute the average range from **VL6180x_RangePollMeasurement()**.
7. Calculate the part-to-part offset as follows:

$$\text{part-to-part offset} = \text{target distance(mm)} - \text{average range(mm)}$$

8. The new offset value should be stored on system and written to the VL6180 by using **VL6180x_SetOffsetCalibrationData()** each time the device is reset.

2.15.4 Cross-talk calibration procedure

This section describes a procedure for calibrating system cross-talk.

1. Perform offset calibration if required (see [Section 2.15.3](#)) and write the value to the device by using **VL6180x_SetOffsetCalibrationData()**.

Note: *If the offset is incorrectly calibrated, cross-talk calibration will be inaccurate.*

2. Read scaling factor **VL6180x_UpscaleGetScaling()**, turn off WAF
VL6180x_FilterSetState() = 0 turn off range ignore features
VL6180x_RangeIgnoreSetEnable() = 0 and clear all interrupts
VL6180x_ClearAllInterrupt().
3. Position a grey target (17% reflectance^(h)) at a distance of 100mm (scaling factor 1) or 300mm (scaling factor 2) or 400mm (scaling factor 3) from the top of the cover glass.
4. Write 0 to **VL6180x_SetXTalkCompensationRate()**.
5. Perform a minimum of 10 range measurements and compute the average return rate and range value from **VL6180x_RangePollMeasurement()**.
6. Calculate the cross-talk factor as follows:

$$\text{cross-talk (in Mcps)} = \text{average return rate} \times \left(1 - \frac{\text{average range(mm)}}{\text{target distance(mm)}}\right)$$

7. The cross-talk value should be stored on system and written to the VL6180 by using **VL6180x_SetXTalkCompensationRate()** each time the device is reset.

g. Target reflectance should be high but absolute value is not critical.

h. Target reflectance should be low but absolute value is not critical.

Note: Cross-talk compensation is only applied to targets above 20 mm. This is to ensure that cross-talk correction is not applied to near targets where the signal rate is decreasing. The API sets the cross-talk valid height dependent on scaling factor. The default is 20mm for scaling 1, 10mm (20/2) for scaling 2 and 7mm (~20/3) for scaling 3.

2.15.5 Cross-talk limit

For proximity ranging (scaling 1), a practical limit for cross-talk is < 3.0 Mcps. This is based on two factors:

1. The return rate for a 3% reflective target at 100 mm without glass is typically around 1.5 Mcps. If glass is added with a cross-talk of 3.0 Mcps, the resultant return rate will be 4.5 Mcps. This results in a cross-talk correction factor of x3 so for a 100 mm target the raw range will be in the region of 30 mm. To ensure the cross-talk valid height restriction is not breached, the minimum raw range allowing for noise margin is around 30 mm.
2. A cross-talk correction factor of x3 also means that any range noise will be multiplied by 3 so noise also becomes a limiting factor.

For extended ranging (scaling 3), a practical limit for cross-talk is < 0.2 Mcps.

2.15.6 Cross-talk vs air gap

Figure 20 shows the typical cross-talk vs air gap using low cross-talk glass. Above 1.5 mm, the cross-talk rises rapidly.

Figure 20. Cross-talk vs air gap

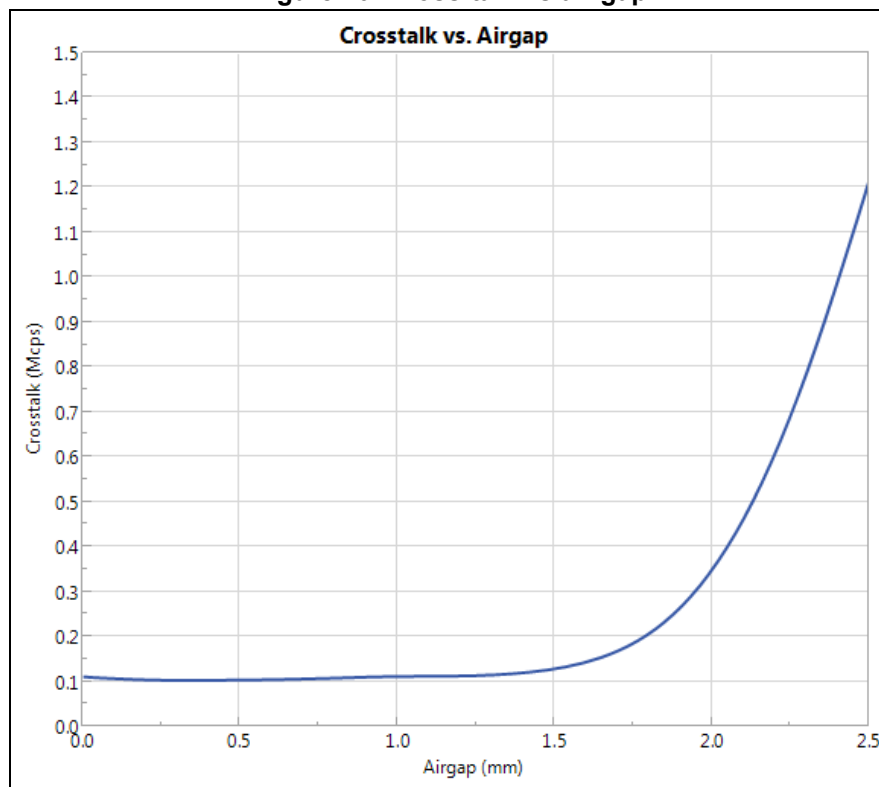

3 Ranging specification

3.1 Proximity ranging (0 to 100mm)

The following table specifies ranging performance up to 100mm. These results are derived from characterization of both typical and corner samples (representative of worst case process conditions).

Unless specified otherwise, all results were performed at room temperature (23°C), nominal voltage (2.8V) and in the dark. Results are based on the average of 100 measurements for a 17% reflective target @ 50mm.

Table 13. Ranging specification 0 to 100mm

Parameter	Min.	Typ.	Max.	Unit
Noise ⁽¹⁾	-	-	2.0	mm
Range offset error ⁽²⁾	-	-	13	mm
Temperature dependent drift ⁽³⁾	-	9	15	mm
Voltage dependent drift ⁽⁴⁾	-	3	5	mm
Convergence time ⁽⁵⁾	-	-	15	ms

1. Maximum standard deviation of 100 measurements
2. Maximum offset drift after 3 reflow cycles. This error can be removed by re-calibration in the final system
3. Tested over optimum operating temperature range (see [Table 20.: Normal operating conditions](#))
4. Tested over optimum operating voltage range (see [Table 20.: Normal operating conditions](#))
5. Based on a 3% reflective target @ 100 mm

3.1.1 Max range vs. ambient light level

The data shown in this section is worst case data **for reference only**.

[Table 14](#) shows the worst case maximum range achievable under different ambient light conditions.

Table 14. Worst case max range vs. ambient 0 to 100mm⁽¹⁾⁽²⁾

Target reflectance	In the dark ⁽³⁾	Worst case indoor light (1 kLux diffuse halogen)	High ambient light (5 kLux diffuse halogen)	Unit
3%	> 100	> 80	> 40	mm
5%	> 100	> 90	> 45	mm
17%	> 100	> 100	> 60	mm
88%	> 100	> 100	> 70	mm

1. Tested in an integrating sphere (repeatable lab test, not representative of real world ambient light) at 1 kLux and 5 kLux (halogen light source) using 80 x 80 mm targets. Due to high IR content, 5 kLux halogen light approximates to 10 kLux to 15 kLux natural sunlight.
2. SNR limit of 0.1 applied. Note: maximum range could be increased by reducing the SNR limit to 0.06
3. Also applicable to lighting conditions with low IR content e.g typical office fluorescent lighting

Figure 21. Typical ranging performance

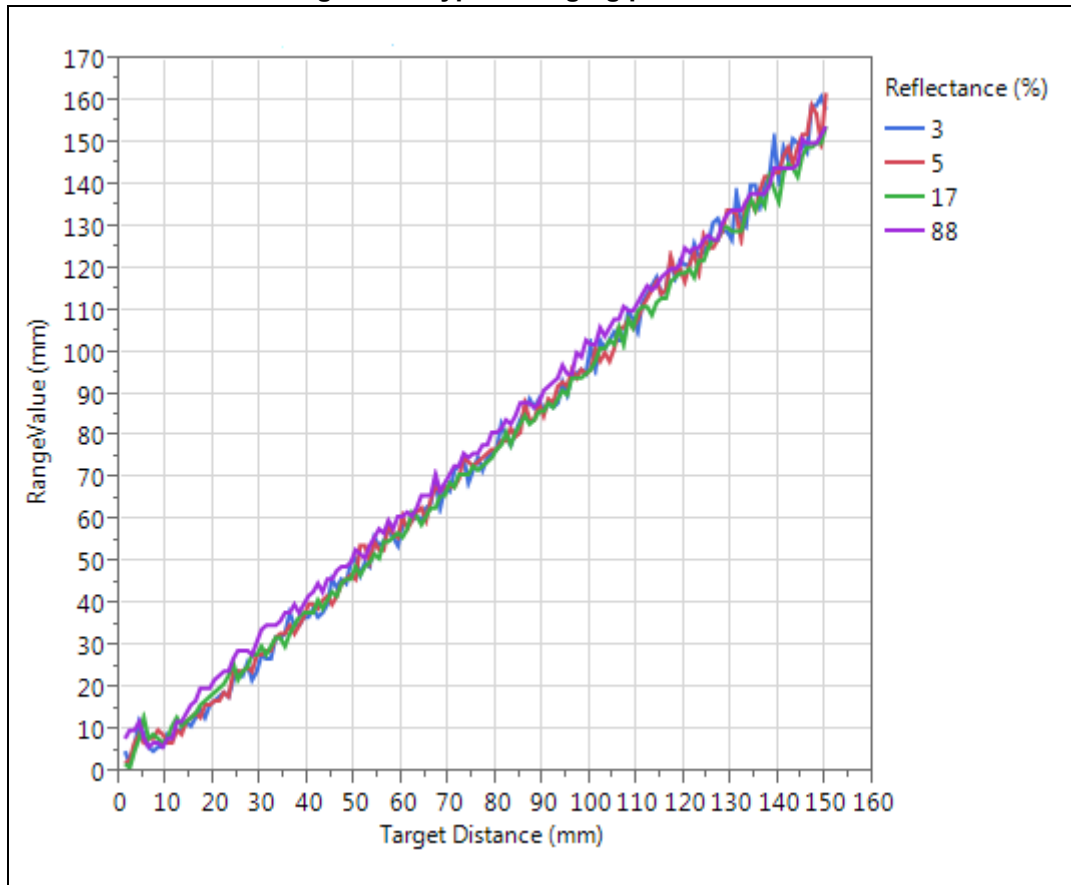

3.2 Extended range (>100mm)

3.2.1 Extended range conditions

Ranging beyond 100 mm requires a low cross-talk system, use of a gasket, small air gap (below 1 mm) and cover glass with IR filter (transmission >80% @ 850nm and <15% @ 450-700nm). Tuning of the following parameters are required:

- SNR limit
- Convergence threshold
- Max convergence time
- Factory calibrated ambient window calibration settings applied by the host

3.2.2 Max range vs. ambient light level

[Table 15](#) shows the worst case maximum range achievable under different ambient light conditions. No cover glass was used in these tests. The device was tuned as per recommendations in [Section 3.2.1](#). The minimum detection rate is the worst case percentage of measurements that will return a valid measurement.

The light source used was a large, adjustable halogen 'theatre' lamp. The lamp was mounted behind the device under test, pointing directly at the test chart, therefore the ambient rate measured by VL6180 is from the light reflected off the test chart.

Table 15. Worst case max range vs. ambient >100mm

Target reflectance (%)	Distance (mm)	Ambient Rate ⁽¹⁾ (Mcps)	Minimum Detection Rate ⁽²⁾ (%)
5	200	3.7	97.5
88	200	37	97.5
17	400	2.1	94.7

1. Ambient light level set at 23°C
2. Over the optimum operating temperature range (-10°C to + 60°C)

[Table 16](#) shows upper and lower measurement limits based on characterization of both typical and limit samples for a 17% target at 400 mm according to the conditions laid out in [Table 15](#). Testing was performed at 2.8 V and over the optimum operating temperature range (-10°C to + 60°C).

Table 16. Range limits for a 400 mm target @ ambient rate 2.1Mcps

Lower limit (mm)	Upper limit (mm)
330	470

The data shown in [Table 17](#) is worst case maximum range data **for reference only** and shows the light levels that can be achieved using a low cross-talk system as defined in [Section 3.2.1](#).

Table 17. Worst case achievable light levels

Target reflectance (%)	Distance (mm)	Equivalent Light level on top of glass (lux)	Notes
5	200	5,200	Sunlight
17	400	950	Halogen light source
88	200	3,700	Sunlight

4 I²C control interface

The VL6180 is controlled over an I²C interface. The default I²C address is 0x29 (7-bit). This section describes the I²C protocol.

Figure 22. Serial interface data transfer protocol

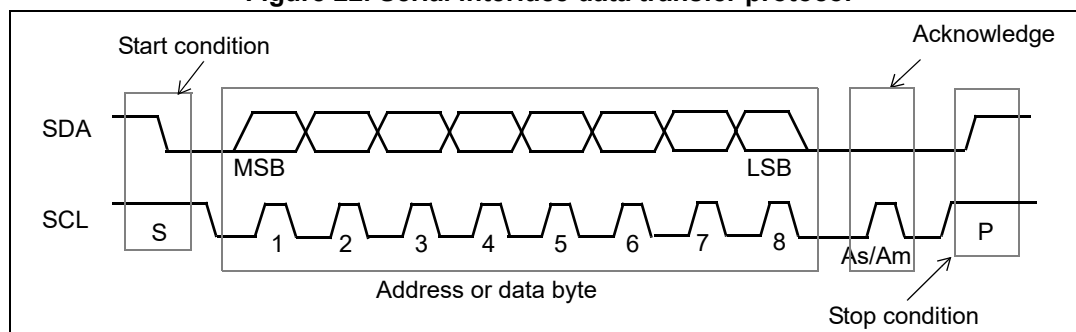

Information is packed in 8-bit packets (bytes) always followed by an acknowledge bit, As for sensor acknowledge and Am for master acknowledge. The internal data is produced by sampling SDA at a rising edge of SCL. The external data must be stable during the high period of SCL. The exceptions to this are start (S) or stop (P) conditions when SDA falls or rises respectively, while SCL is high.

A message contains a series of bytes preceded by a start condition and followed by either a stop or repeated start (another start condition but without a preceding stop condition) followed by another message. The first byte contains the device address (0x52) and also specifies the data direction. If the least significant bit is low (0x52) the message is a master write to the slave. If the lsb is set (0x53) then the message is a master read from the slave.

Figure 23. I²C device address

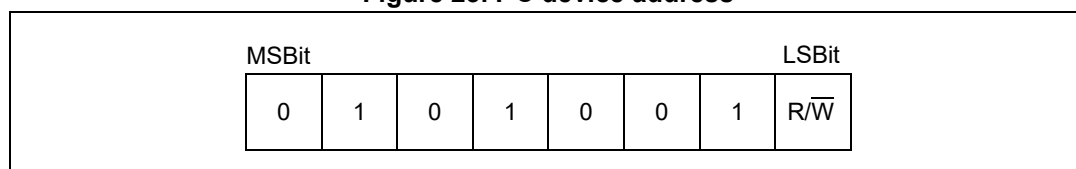

All serial interface communications with the sensor must begin with a start condition. The sensor acknowledges the receipt of a valid address by driving the SDA wire low. The state of the read/write bit (lsb of the address byte) is stored and the next byte of data, sampled from SDA, can be interpreted. During a write sequence the second and third bytes received provide a 16-bit index which points to one of the internal 8-bit registers.

Figure 24. Single location, single write

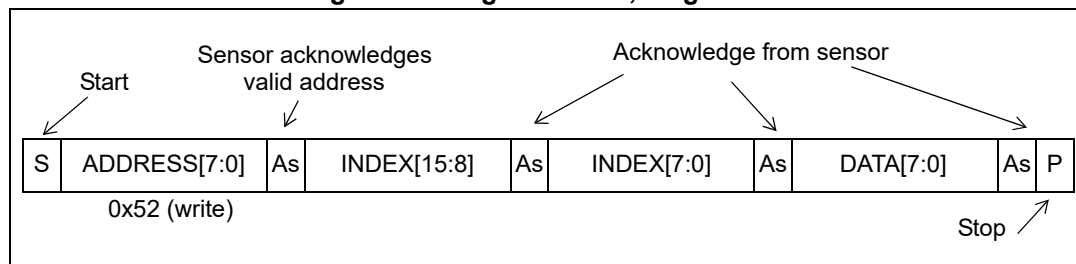

As data is received by the slave it is written bit by bit to a serial/parallel register. After each data byte has been received by the slave, an acknowledge is generated, the data is then stored in the internal register addressed by the current index.

During a read message, the contents of the register addressed by the current index is read out in the byte following the device address byte. The contents of this register are parallel loaded into the serial/parallel register and clocked out of the device by the falling edge of SCL.

Figure 25. Single location, single read

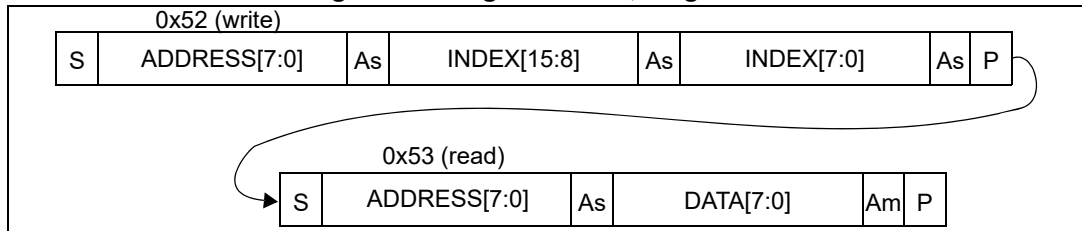

At the end of each byte, in both read and write message sequences, an acknowledge is issued by the receiving device (that is, the sensor for a write and the master for a read).

A message can only be terminated by the bus master, either by issuing a stop condition or by a negative acknowledge (that is, **not** pulling the SDA line low) after reading a complete byte during a read operation.

The interface also supports auto-increment indexing. After the first data byte has been transferred, the index is automatically incremented by 1. The master can therefore send data bytes continuously to the slave until the slave fails to provide an acknowledge or the master terminates the write communication with a stop condition. If the auto-increment feature is used the master does **not** have to send address indexes to accompany the data bytes.

Figure 26. Multiple location write

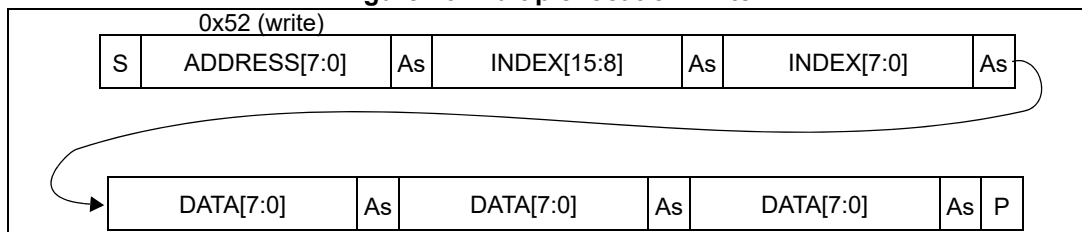
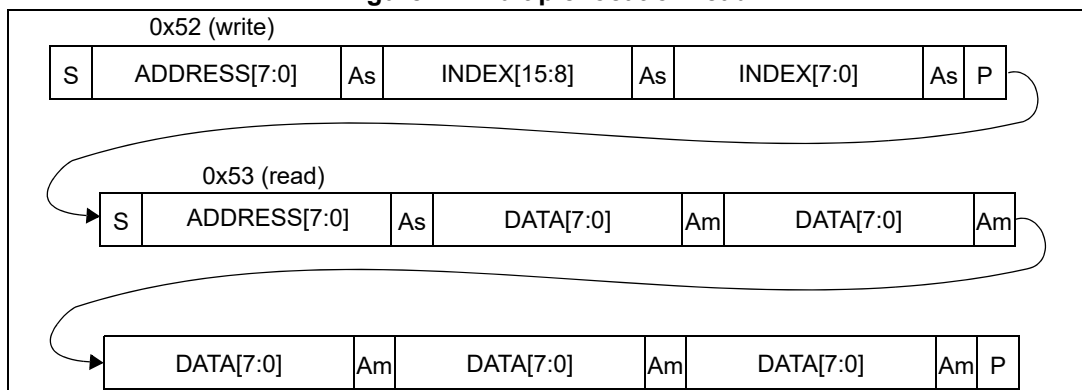

Figure 27. Multiple location read



4.1 I²C interface - timing characteristics

Timing characteristics are shown in [Table 18](#). Please refer to [Figure 28](#) for an explanation of the parameters used.

Table 18. I²C interface - timing characteristics

Symbol	Parameter	Minimum	Typical	Maximum	Unit
F _{I2C}	Operating frequency	0	-	400 ⁽¹⁾	kHz
t _{LOW}	Clock pulse width low	0.5	-	-	μs
t _{HIGH}	Clock pulse width high	0.26	-	-	μs
t _{SP}	Pulse width of spikes which are suppressed by the input filter	-	-	50	ns
t _{BUF}	Bus free time between transmissions	0.5	-	-	μs
t _{HD.STA}	Start hold time	0.26	-	-	μs
t _{SU.STA}	Start set-up time	0.26	-	-	μs
t _{HD.DAT}	Data in hold time	0	-	-	μs
t _{SU.DAT}	Data in set-up time	50	-	-	ns
t _R	SCL/SDA rise time	-	-	120	ns
t _F	SCL/SDA fall time	-	-	120	ns
t _{SU.STO}	Stop set-up time	0.26	-	-	μs
C _{i/o}	Input/output capacitance (SDA)	-	-	4	pF
C _{in}	Input capacitance (SCL)	-	-	4	pF
C _L	Load capacitance	-	125	-	pF

1. The maximum bus speed may also be limited by the combination of load capacitance and pull-up resistor. Please refer to the I²C specification for further information.

Figure 28. I²C timing characteristics

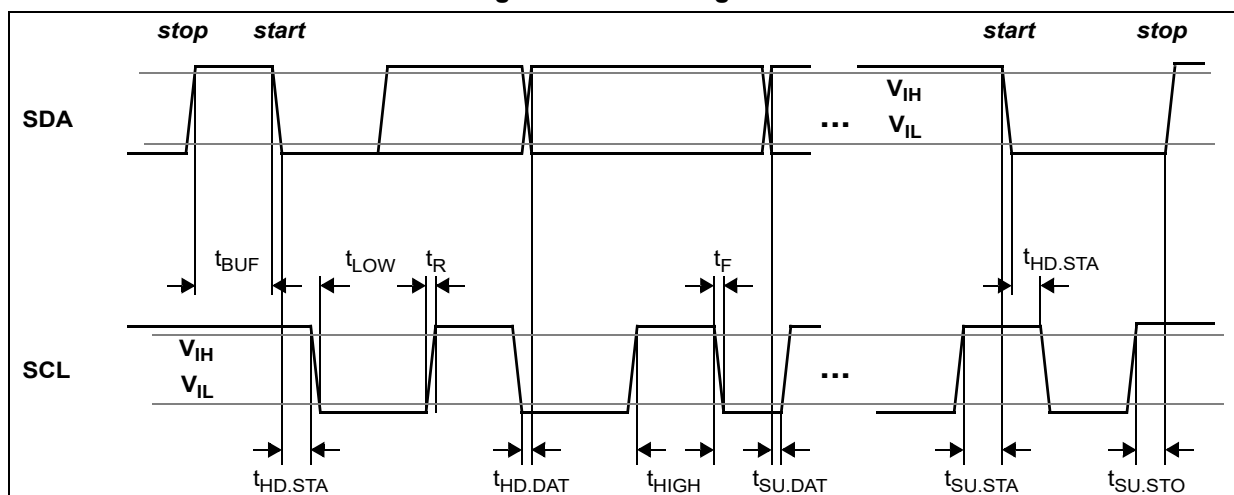

Note: All timing characteristics are measured with respect to V_{IL_MAX} or V_{IH_MIN}.

5 Electrical characteristics

5.1 Absolute maximum ratings

Table 19. Absolute maximum ratings

Parameter	Min.	Typ.	Max.	Unit
AVDD	-0.5	-	3.6	V
AVDD_VCSEL	-0.5	-	3.6	V
SCL, SDA, GPIO0 and GPIO1	-0.5	-	3.6	V
VESD (Electrostatic discharge model)				
Human body model ⁽¹⁾	-2		2	KV
Charge device model ⁽²⁾	-500		500	V
Temperature (storage - manufacturing test)	-40	-	+85	°C

1. HBM tests are performed in compliance with ESDA/JEDEC JS-001-2010 (ex: JESD22-A114)
MM test is performed in compliance with JESD22-A115.
2. CDM ESD tests are performed in compliance with JESD22-C101.

Note: Stresses above those listed in [Table 19](#) may cause permanent damage to the device. This is a stress rating only and functional operation of the device at these or any other conditions above those indicated in the operational sections of the specification is not implied. Exposure to absolute maximum rating conditions for extended periods may affect device reliability.

5.2 Normal operating conditions

Table 20. Normal operating conditions

Parameter	Min.	Typ.	Max.	Unit
Voltage (AVDD and AVDD_VCSEL)				
Voltage (optimum operating)	2.7	2.8	2.9	V
Voltage (functional operating)	2.6	2.8	3.0	V
Temperature				
Temperature (optimum operating)	-10		+60	°C
Temperature (functional operating)	-20	-	+70	°C

5.3 Electrical characteristics

Table 21. Digital I/O electrical characteristics

Symbol	Parameter	Minimum	Typical	Maximum	Unit
CMOS digital I/O (SDA, SCL, GPIO0 and GPIO1)					
V _{IL}	Low level input voltage	-0.5	-	0.6	V
V _{IH}	High level input voltage	1.12	-	AVDD+0.5	V
V _{OL}	Low level output voltage (8mA load)	-	-	0.4	V
V _{OH}	High level output voltage (8mA load)	AVDD-0.4	-	-	V
I _{IL}	Low level input current	-	-	-10	μA
I _{IH}	High level input current	-	-	10	μA

6 Device registers

This section describes in detail all user accessible device registers. Registers are grouped by function as shown in [Table 22](#), to make them easier to read but also to simplify multi-byte read/write I²C accesses (burst mode). More details in [Section 4](#). Reset values are given for each register which denotes the register value in software standby.

Table 22. Register groups

Register group	Address range
IDENTIFICATION	0x000 - 0x00F
SYSTEM SETUP	0x010 - 0x017
RANGE SETUP	0x018 - 0x037
RESULTS	0x04D - 0x080

Note that registers can be 8-, 16- or 32-bit. Multi-byte registers are always addressed in ascending order with MSB first as shown in [Table 23](#).

Table 23. 32-bit register example

Register address	Byte
Address	MSB
Address + 1	..
Address + 2	..
Address + 3	LSB

6.1 Register encoding formats

Some registers are encoded to allow rational numbers to be expressed efficiently. [Table 24](#) gives an explanation of 9.7 and 4.4 encoding formats. [Table 25](#) gives a summary of the device registers.

Table 24. Register formats

Format	Description
9.7	9 integer bits + 7 fractional bits (stored over 2 bytes) For example, the value 4.2 is multiplied by 128, rounded and stored as 537 decimal. To decode, divide 537 by 128 = 4.19.

Table 25. Register summary

Address	Register name	Reference
0x000	IDENTIFICATION__MODEL_ID	Section 6.2.1 on page 42
0x001	IDENTIFICATION__MODEL_REV_MAJOR	Section 6.2.2 on page 42
0x002	IDENTIFICATION__MODEL_REV_MINOR	Section 6.2.3 on page 42
0x003	IDENTIFICATION__MODULE_REV_MAJOR	Section 6.2.4 on page 43
0x004	IDENTIFICATION__MODULE_REV_MINOR	Section 6.2.5 on page 43
0x006	IDENTIFICATION__DATE_HI	Section 6.2.6 on page 43
0x007	IDENTIFICATION__DATE_LO	Section 6.2.7 on page 44
0x008:0x009	IDENTIFICATION__TIME	Section 6.2.8 on page 44
0x010	SYSTEM__MODE_GPIO0	Section 6.2.9 on page 45
0x011	SYSTEM__MODE_GPIO1	Section 6.2.10 on page 46
0x012	SYSTEM__HISTORY_CTRL	Section 6.2.11 on page 47
0x014	SYSTEM__INTERRUPT_CONFIG_GPIO	Section 6.2.12 on page 48
0x015	SYSTEM__INTERRUPT_CLEAR	Section 6.2.13 on page 48
0x016	SYSTEM__FRESH_OUT_OF_RESET	Section 6.2.14 on page 48
0x017	SYSTEM__GROUPED_PARAMETER_HOLD	Section 6.2.15 on page 49
0x018	SYSRANGE__START	Section 6.2.16 on page 49
0x019	SYSRANGE__THRESH_HIGH	Section 6.2.17 on page 50
0x01A	SYSRANGE__THRESH_LOW	Section 6.2.18 on page 51
0x01B	SYSRANGE__INTERMEASUREMENT_PERIOD	Section 6.2.19 on page 51
0x01C	SYSRANGE__MAX_CONVERGENCE_TIME	Section 6.2.20 on page 51
0x01E	SYSRANGE__CROSSTALK_COMPENSATION_RATE	Section 6.2.21 on page 52
0x021	SYSRANGE__CROSSTALK_VALID_HEIGHT	Section 6.2.22 on page 52
0x022	SYSRANGE__EARLY_CONVERGENCE_ESTIMATE	Section 6.2.23 on page 52
0x024	SYSRANGE__PART_TO_PART_RANGE_OFFSET	Section 6.2.24 on page 53
0x025	SYSRANGE__RANGE_IGNORE_VALID_HEIGHT	Section 6.2.25 on page 53
0x026	SYSRANGE__RANGE_IGNORE_THRESHOLD	Section 6.2.26 on page 53
0x02C	SYSRANGE__MAX_AMBIENT_LEVEL_MULT	Section 6.2.27 on page 54
0x02D	SYSRANGE__RANGE_CHECK_ENABLES	Section 6.2.27 on page 54
0x02E	SYSRANGE__VHV_RECALIBRATE	Section 6.2.29 on page 55
0x031	SYSRANGE__VHV_REPEAT_RATE	Section 6.2.30 on page 55
0x04D	RESULT__RANGE_STATUS	Section 6.2.31 on page 56
0x04F	RESULT__INTERRUPT_STATUS_GPIO	Section 6.2.32 on page 57
0x052:0x060 (0x2)	RESULT__HISTORY_BUFFER_x	Section 6.2.33 on page 57
0x062	RESULT__RANGE_VAL	Section 6.2.34 on page 58

Table 25. Register summary (continued)

Address	Register name	Reference
0x064	RESULT__RANGE_RAW	Section 6.2.35 on page 58
0x066	RESULT__RANGE_RETURN_RATE	Section 6.2.36 on page 59
0x068	RESULT__RANGE_REFERENCE_RATE	Section 6.2.37 on page 60
0x06C	RESULT__RANGE_RETURN_SIGNAL_COUNT	Section 6.2.38 on page 60
0x070	RESULT__RANGE_REFERENCE_SIGNAL_COUNT	Section 6.2.39 on page 61
0x074	RESULT__RANGE_RETURN_AMB_COUNT	Section 6.2.40 on page 61
0x078	RESULT__RANGE_REFERENCE_AMB_COUNT	Section 6.2.41 on page 61
0x07C	RESULT__RANGE_RETURN_CONV_TIME	Section 6.2.42 on page 62
0x080	RESULT__RANGE_REFERENCE_CONV_TIME	Section 6.2.43 on page 62
0x10A	READOUT__AVERAGING_SAMPLE_PERIOD	Section 6.2.44 on page 62
0x119	FIRMWARE__BOOTUP	Section 6.2.44 on page 62
0x212	I2C_SLAVE__DEVICE_ADDRESS	Section 6.2.46 on page 63

6.2 Register descriptions

6.2.1 IDENTIFICATION__MODEL_ID

7	6	5	4	3	2	1	0
identification__model_id							
R/W							

Address: 0x000

Type: R/W

Reset: 0xB4

Description:

[7:0]	identification__model_id: Device model identification number. 0xB4 = VL6180
-------	---

6.2.2 IDENTIFICATION__MODEL_REV_MAJOR

7	6	5	4	3	2	1	0
RESERVED					identification__model_rev_major		
R					R/W		

Address: 0x001

Type: R/W

Reset: 0x01

Description:

[2:0]	identification__model_rev_major: Revision identifier of the Device for major change.
-------	--

6.2.3 IDENTIFICATION__MODEL_REV_MINOR

7	6	5	4	3	2	1	0
RESERVED					identification__model_rev_minor		
R					R/W		

Address: 0x002

Type: R/W

Reset: 0x03, register default overwritten at boot-up by NVM contents.

Description:

[2:0]	identification__model_rev_minor: Revision identifier of the Device for minor change. IDENTIFICATION__MODEL_REV_MINOR = 3 for latest ROM revision
-------	---

6.2.4 IDENTIFICATION__MODULE_REV_MAJOR

7	6	5	4	3	2	1	0
RESERVED					identification__module_rev_major		
R					R/W		

Address: 0x003

Type: R/W

Reset: 0xXX, register default overwritten at boot-up by NVM contents.

Description:

[2:0]	identification__module_rev_major: Revision identifier of the Module Package for major change. Used to store NVM content version. Contact ST for current information. VL6180V0NR1: 001 VL6180V1NR1: 010
-------	--

6.2.5 IDENTIFICATION__MODULE_REV_MINOR

7	6	5	4	3	2	1	0
RESERVED					identification__module_rev_minor		
R					R/W		

Address: 0x004

Type: R/W

Reset: 0xXX

Description:

[2:0]	identification__module_rev_minor: Revision identifier of the Module Package for minor change. Used to store NVM content version. Contact ST for current information. VL6180V0NR1: 010 VL6180V1NR1: 000
-------	--

6.2.6 IDENTIFICATION__DATE_HI

7	6	5	4	3	2	1	0
identification__year				identification__month			
R/W				R/W			

Address: 0x006

Type: R/W

Reset: 0xYY, register default overwritten at boot-up by NVM contents.

Description: Part of the register set that can be used to uniquely identify a module.

[7:4]	identification__year: Last digit of manufacturing year (bits[3:0]).
[3:0]	identification__month: Manufacturing month (bits[3:0]).

6.2.7 IDENTIFICATION__DATE_LO

7	6	5	4	3	2	1	0
identification__day				identification__phase			
R/W				R/W			

Address: 0x007

Type: R/W

Reset: 0xYY, register default overwritten at boot-up by NVM contents.

Description: Part of the register set that can be used to uniquely identify a module.

[7:3]	identification__day: Manufacturing day (bits[4:0]).
[2:0]	identification__phase: Manufacturing phase identification (bits[2:0]).

6.2.8 IDENTIFICATION__TIME

15	14	13	12	11	10	9	8	7	6	5	4	3	2	1	0
identification__time															
R/W															

Address: 0x008:0x009

Type: R/W

Reset: 0xYYYY, register default overwritten at boot-up by NVM contents.

Description: Part of the register set that can be used to uniquely identify a module.

[15:0]	identification__time: Time since midnight (in seconds) = register_value * 2.
--------	--

6.2.9 SYSTEM__MODE_GPIO0

7	6	5	4	3	2	1	0
RESERVED	system__gpio0_is_xshutdown	system__gpio0_polarity	system__gpio0_select			RESERVED	
R	R/W	R/W	R/W			R/W	

Address: 0x010

Type: R/W

Reset: 0x60

Description:

[6]	system__gpio0_is_xshutdown: Priority mode - when enabled, other bits of the register are ignored. GPIO0 is main XSHUTDOWN input. 0: Disabled 1: Enabled - GPIO0 is main XSHUTDOWN input.
[5]	system__gpio0_polarity: Signal Polarity Selection. 0: Active-low 1: Active-high
[4:1]	system__gpio0_select: Functional configuration options. 0000: OFF (Hi-Z) 1000: GPIO Interrupt output
[0]	Reserved. Write 0.

6.2.10 SYSTEM__MODE_GPIO1

7	6	5	4	3	2	1	0
RESERVED		system__gpio1_polarity	system__gpio1_select				RESERVED
R		R/W	R/W				R/W

Address: 0x011

Type: R/W

Reset: 0x20

Description:

[5]	system__gpio1_polarity: Signal Polarity Selection. 0: Active-low 1: Active-high
[4:1]	system__gpio1_select: Functional configuration options. 0000: OFF (Hi-Z) 1000: GPIO Interrupt output
[0]	Reserved. Write 0.

6.2.11 SYSTEM__HISTORY_CTRL

7	6	5	4	3	2	1	0
RESERVED					system__history_buffer_clear	system__history_buffer_mode	system__history_buffer_enable
R					R/W	R/W	R/W

Address: 0x012

Type: R/W

Reset: 0x0

Description:

[2]	system__history_buffer_clear: User-command to clear history (FW will auto-clear this bit when clear has completed). 0: Disabled 1: Clear all history buffers
[1]	system__history_buffer_mode: Select mode buffer results for: 0: Ranging (stores the last 8 ranging values (8-bit)) 1: n/a
[0]	system__history_buffer_enable: Enable History buffering. 0: Disabled 1: Enabled

6.2.12 SYSTEM_INTERRUPT_CONFIG_GPIO

7	6	5	4	3	2	1	0
RESERVED		RESERVED			range_int_mode		
R		R/W			R/W		

Address: 0x014

Type: R/W

Reset: 0x0

Description:

[2:0]	range_int_mode: Interrupt mode source for Range readings: 0: Disabled 1: Level Low (value < thresh_low) 2: Level High (value > thresh_high) 3: Out Of Window (value < thresh_low OR value > thresh_high) 4: New sample ready
-------	---

6.2.13 SYSTEM_INTERRUPT_CLEAR

7	6	5	4	3	2	1	0
RESERVED					int_clear_sig		
R					R/W		

Address: 0x015

Type: R/W

Reset: 0x0

Description:

[2:0]	int_clear_sig: Interrupt clear bits Writing a 1 to each bit will clear the intended interrupt note that the int is only cleared upon the write command itself. Bit [0] - Clear Range Int Bit [1] - Reserved Bit [2] - Clear Error Int.
-------	---

6.2.14 SYSTEM_FRESH_OUT_OF_RESET

7	6	5	4	3	2	1	0
RESERVED							fresh_out_of_reset
R							R/W

Address: 0x016

Type: R/W

Reset: 0x1

Description:

[0]	fresh_out_of_reset: Fresh out of reset bit, default of 1, user can set this to 0 after initial boot and can therefore use this to check for a reset condition
-----	---

6.2.15 SYSTEM__GROUPED_PARAMETER_HOLD

7	6	5	4	3	2	1	0
RESERVED							grouped_parameter_hold
R							R/W

Address: 0x017

Type: R/W

Reset: 0x0

Description:

[0]	grouped_parameter_hold: Flag set over I ² C to indicate that data is being updated 0: Data is stable - FW is safe to copy 1: Data being updated - FW not safe to copy Usage: set to 0x01 first, write any of the registers listed below, then set to 0x00 so that the settings are used by the firmware at the start of the next measurement. SYSTEM__INTERRUPT_CONFIG_GPIO SYSRANGE__THRESH_HIGH SYSRANGE__THRESH_LOW
-----	---

6.2.16 SYSRANGE__START

7	6	5	4	3	2	1	0
RESERVED						sysrange__mode_select	sysrange__startstop
R						R/W	R/W

Address: 0x018

Type: R/W

Reset: 0x0



Description:

[1]	sysrange__mode_select: Device Mode select 0: Ranging Mode Single-Shot 1: Ranging Mode Continuous
[0]	sysrange__startstop: StartStop trigger based on current mode and system configuration of device_ready. FW clears register automatically. Setting this bit to 1 in single-shot mode starts a single measurement. Setting this bit to 1 in continuous mode will either start continuous operation (if stopped) or halt continuous operation (if started). This bit is auto-cleared in both modes of operation.

6.2.17 SYSRANGE__THRESH_HIGH

7	6	5	4	3	2	1	0
sysrange__thresh_high							
R/W							

Address: 0x019

Type: R/W

Reset: 0xFF

Description:

[7:0]	sysrange__thresh_high: High Threshold value for ranging comparison. Range 0-255mm.
-------	--

6.2.18 SYSRANGE__THRESH_LOW

7	6	5	4	3	2	1	0
sysrange__thresh_low							
R/W							

Address: 0x01A**Type:** R/W**Reset:** 0x0**Description:**

[7:0]	sysrange__thresh_low: Low Threshold value for ranging comparison. Range 0-255mm.
-------	--

6.2.19 SYSRANGE__INTERMEASUREMENT_PERIOD

7	6	5	4	3	2	1	0
sysrange__intermeasurement_period							
R/W							

Address: 0x01B**Type:** R/W**Reset:** 0xFF**Description:**

[7:0]	sysrange__intermeasurement_period: Time delay between measurements in Ranging continuous mode. Range 0-254 (0 = 10ms). Step size = 10ms.
-------	--

6.2.20 SYSRANGE__MAX_CONVERGENCE_TIME

7	6	5	4	3	2	1	0
RESERVED		sysrange__max_convergence_time					
R		R/W					

Address: 0x01C**Type:** R/W**Reset:** 0x31**Description:**

[5:0]	sysrange__max_convergence_time: Maximum time to run measurement in Ranging modes. Range 1 - 63 ms (1 code = 1 ms); Measurement aborted when limit reached to aid power reduction. For example, 0x01 = 1ms, 0x0a = 10ms. Note: Effective max_convergence_time depends on readout_averaging_sample_period setting.
-------	---

6.2.21 SYSRANGE__CROSSTALK_COMPENSATION_RATE

15	14	13	12	11	10	9	8	7	6	5	4	3	2	1	0
sysrange__crosstalk_compensation_rate															
R/W															

Address: 0x01E

Type: R/W

Reset: 0x0

Description:

[15:0]	sysrange__crosstalk_compensation_rate: User-controlled cross-talk compensation in Mcps (9.7 format)
--------	---

6.2.22 SYSRANGE__CROSSTALK_VALID_HEIGHT

7	6	5	4	3	2	1	0
sysrange__crosstalk_valid_height							
R/W							

Address: 0x021

Type: R/W

Reset: 0x14

Description:

[7:0]	sysrange__crosstalk_valid_height: Minimum range value in mm to qualify for cross-talk compensation.
-------	---

6.2.23 SYSRANGE__EARLY_CONVERGENCE_ESTIMATE

15	14	13	12	11	10	9	8	7	6	5	4	3	2	1	0
sysrange__early_convergence_estimate															
R/W															

Address: 0x022

Type: R/W

Reset: 0x0

Description:

[15:0]	FW carries out an estimate of convergence rate 0.5ms into each new range measurement. If convergence rate is below user input value, the operation aborts to save power. Note: This register must be configured otherwise ECE should be disabled via SYSRANGE__RANGE_CHECK_ENABLES.
--------	--

6.2.24 SYSRANGE__PART_TO_PART_RANGE_OFFSET

7	6	5	4	3	2	1	0
sysrange__part_to_part_range_offset							
R/W							

Address: 0x024**Type:** R/W**Reset:** 0xYY, register default overwritten at boot-up by NVM contents.**Description:**

[7:0]	sysrange__part_to_part_range_offset: 2s complement.
-------	---

6.2.25 SYSRANGE__RANGE_IGNORE_VALID_HEIGHT

7	6	5	4	3	2	1	0
sysrange__range_ignore_valid_height							
R/W							

Address: 0x025**Type:** R/W**Reset:** 0x0, register default overwritten at boot-up by NVM contents.**Description:**

[7:0]	sysrange__range_ignore_valid_height: Range below which ignore threshold is applied. Aim is to ignore the cover glass i.e. low signal rate at near distance. Should not be applied to low reflectance target at far distance. Range in mm. Note: It is recommended to set this register to 255 if the range ignore feature is used.
-------	---

6.2.26 SYSRANGE__RANGE_IGNORE_THRESHOLD

15	14	13	12	11	10	9	8	7	6	5	4	3	2	1	0
sysrange__range_ignore_threshold															
R/W															

Address: 0x026**Type:** R/W**Reset:** 0x00**Description:**

[15:0]	sysrange__range_ignore_threshold: User input min threshold signal return rate. Used to filter out ranging due to cover glass when there is no target above the device. Mcps 9.7 format. Note: Register must be initialized if this feature is used.
--------	--

6.2.27 SYSRANGE__MAX_AMBIENT_LEVEL_MULT

7	6	5	4	3	2	1	0
sysrange__max_ambient_level_mult							
R/W							

Address: 0x02C

Type: R/W

Reset: 0xA0, register default overwritten at boot-up by NVM contents.

Description:

[7:0]	sysrange__max_ambient_level_mult: User input value to multiply return_signal_count for AMB:signal ratio check. If amb counts > return_signal_count * mult then abandon measurement due to high ambient (4.4 format).
-------	--

6.2.28 SYSRANGE__RANGE_CHECK_ENABLES

7	6	5	4	3	2	1	0
RESERVED			sysrange__signal_to_noise_enable	0	0	sysrange__range_ignore_enable	sysrange__early_convergence_enable
R			R/W	R/W	R	R/W	R/W

Address: 0x02D

Type: R/W

Reset: 0x11, register default overwritten at boot-up by NVM contents.

Description:

[4]	sysrange__signal_to_noise_enable: Measurement enable/disable
[1]	sysrange__range_ignore_enable: Measurement enable/disable
[0]	sysrange__early_convergence_enable: Measurement enable/disable

6.2.29 SYSRANGE__VHV_RECALIBRATE

7	6	5	4	3	2	1	0
RESERVED						sysrange__vhv_status	sysrange__vhv_recalibrate
R						R/W	R/W

Address: 0x02E

Type: R/W

Reset: 0x0

Description:

[1]	sysrange__vhv_status: FW controlled status bit showing when FW has completed auto-vhv process. 0: FW has finished autoVHV operation 1: During autoVHV operation
[0]	sysrange__vhv_recalibrate: User-Controlled enable bit to force FW to carry out recalibration of the VHV setting for sensor array. FW clears bit after operation carried out. 0: Disabled 1: Manual trigger for VHV recalibration. Can only be called when ranging is in STOP mode

6.2.30 SYSRANGE__VHV_REPEAT_RATE

7	6	5	4	3	2	1	0
sysrange__vhv_repeate_rate							
R/W							

Address: 0x031

Type: R/W

Reset: 0x0

Description:

[7:0]	sysrange__vhv_repeate_rate: User entered repeat rate of auto VHV task (0 = off, 255 = after every 255 measurements)
-------	---

6.2.31 RESULT_RANGE_STATUS

7	6	5	4	3	2	1	0
result__range_error_code				result__range_min_threshold_hit	result__range_max_threshold_hit	result__range_measurement_ready	result__range_device_ready
R				R	R	R	R

Address: 0x04D

Type: R

Reset: 0x1

Description:

[7:4]	result__range_error_code: Specific error codes 0000: No error 0001: VCSEL Continuity Test 0010: VCSEL Watchdog Test 0011: VCSEL Watchdog 0100: PLL1 Lock 0101: PLL2 Lock 0110: Early Convergence Estimate 0111: Max Convergence 1000: No Target Ignore 1001: Not used 1010: Not used 1011: Max Signal To Noise Ratio 1100: Raw Ranging Algo Underflow 1101: Raw Ranging Algo Overflow 1110: Ranging Algo Underflow 1111: Ranging Algo Overflow
[3]	result__range_min_threshold_hit: Legacy register - DO NOT USE Use instead 6.2.32: RESULT_INTERRUPT_STATUS_GPIO .
[2]	result__range_max_threshold_hit: Legacy register - DO NOT USE Use instead 6.2.32: RESULT_INTERRUPT_STATUS_GPIO .
[1]	result__range_measurement_ready: Legacy register - DO NOT USE Use instead 6.2.32: RESULT_INTERRUPT_STATUS_GPIO .
[0]	result__range_device_ready: Device Ready. When set to 1, indicates the device mode and configuration can be changed and a new start command will be accepted. When 0, indicates the device is busy. Any new start commands will be ignored until device is ready. (RO).

6.2.32 RESULT_INTERRUPT_STATUS_GPIO

7	6	5	4	3	2	1	0
result_int_error_gpio		RESERVED			result_int_range_gpio		
R		R			R		

Address: 0x04F

Type: R

Reset: 0x0

Description:

[7:6]	result_int_error_gpio: Interrupt bits for Error: 0: No error reported 1: Laser Safety Error 2: PLL error (either PLL1 or PLL2)
[2:0]	result_int_range_gpio: Interrupt bits for Range: 0: No threshold events reported 1: Level Low threshold event 2: Level High threshold event 3: Out Of Window threshold event 4: New Sample Ready threshold event

6.2.33 RESULT_HISTORY_BUFFER_x

	15	14	13	12	11	10	9	8	7	6	5	4	3	2	1	0
RESULT_HISTORY_BUFFER_0	result_history_buffer_0															
RESULT_HISTORY_BUFFER_1	result_history_buffer_1															
RESULT_HISTORY_BUFFER_2	result_history_buffer_2															
RESULT_HISTORY_BUFFER_3	result_history_buffer_3															
RESULT_HISTORY_BUFFER_4	result_history_buffer_4															
RESULT_HISTORY_BUFFER_5	result_history_buffer_5															
RESULT_HISTORY_BUFFER_6	result_history_buffer_6															
RESULT_HISTORY_BUFFER_7	result_history_buffer_7															
	R															

Address: 0x052 + x * 0x2 (x=0 to 7)

Type: R

Reset: 0x0

Description: See also [6.2.11: SYSTEM_HISTORY_CTRL](#)

RESULT__HISTORY_BUFFER_0: [15:0]	result__history_buffer_0: Range result value. Range mode; Bits[15:8] range_val_latest; Bits[7:0] range_val_d1;
RESULT__HISTORY_BUFFER_1: [15:0]	result__history_buffer_1: Range result value. Range mode; Bits[15:8] range_val_d2; Bits[7:0] range_val_d3;
RESULT__HISTORY_BUFFER_2: [15:0]	result__history_buffer_2: Range result value. Range mode; Bits[15:8] range_val_d4; Bits[7:0] range_val_d5;
RESULT__HISTORY_BUFFER_3: [15:0]	result__history_buffer_3: Range result value. Range mode; Bits[15:8] range_val_d6; Bits[7:0] range_val_d7;
RESULT__HISTORY_BUFFER_4: [15:0]	result__history_buffer_4: Range result value. Range mode; Bits[15:8] range_val_d8; Bits[7:0] range_val_d9;
RESULT__HISTORY_BUFFER_5: [15:0]	result__history_buffer_5: Range result value. Range mode; Bits[15:8] range_val_d10; Bits[7:0] range_val_d11;
RESULT__HISTORY_BUFFER_6: [15:0]	result__history_buffer_6: Range result value. Range mode; Bits[15:8] range_val_d12; Bits[7:0] range_val_d13;
RESULT__HISTORY_BUFFER_7: [15:0]	result__history_buffer_7: Range result value. Range mode; Bits[15:8] range_val_d14; Bits[7:0] range_val_d15;

6.2.34 RESULT__RANGE_VAL

7	6	5	4	3	2	1	0
result__range_val							
R							

Address: 0x062

Type: R

Reset: 0x0

Description:

[7:0]	result__range_val: Final range result value presented to the user for use. Unit is in mm.
-------	---

6.2.35 RESULT__RANGE_RAW

7	6	5	4	3	2	1	0
result__range_raw							
R							

Address: 0x064

Type: R

Reset: 0x0

Description:

[7:0]	result__range_raw: Raw Range result value with offset applied (no cross-talk compensation applied).
-------	---

6.2.36 RESULT__RANGE_RETURN_RATE

15	14	13	12	11	10	9	8	7	6	5	4	3	2	1	0
result__range_return_rate															
R															

Address: 0x066

Type: R

Reset: 0x0

Description:

[15:0]	result__range_return_rate: sensor count rate of signal returns correlated to IR emitter. Computed from RETURN_SIGNAL_COUNT / RETURN_CONV_TIME. Mcps 9.7 format
--------	--

6.2.37 RESULT__RANGE_REFERENCE_RATE

15	14	13	12	11	10	9	8	7	6	5	4	3	2	1	0
result__range_reference_rate															
R															

Address: 0x068

Type: R

Reset: 0x0

Description:

[15:0]	result__range_reference_rate: sensor count rate of reference signal returns. Computed from REFERENCE_SIGNAL_COUNT / RETURN_CONV_TIME. Mcps 9.7 format Note: Both arrays converge at the same time, so using the return array convergence time is correct.
--------	--

6.2.38 RESULT__RANGE_RETURN_SIGNAL_COUNT

31	30	29	28	27	26	25	24	23	22	21	20	19	18	17	16	15	14	13	12	11	10	9	8	7	6	5	4	3	2	1	0		
result__range_return_signal_count																																	
R																																	

Address: 0x06C

Type: R

Reset: 0x0

Description:

[31:0]	result__range_return_signal_count: sensor count output value attributed to signal correlated to IR emitter on the Return array.
--------	---

6.2.39 RESULT__RANGE_REFERENCE_SIGNAL_COUNT

31	30	29	28	27	26	25	24	23	22	21	20	19	18	17	16	15	14	13	12	11	10	9	8	7	6	5	4	3	2	1	0
result__range_reference_signal_count																															
R																															

Address: 0x070**Type:** R**Reset:** 0x0**Description:**

[31:0]	result__range_reference_signal_count: sensor count output value attributed to signal correlated to IR emitter on the Reference array.
--------	---

6.2.40 RESULT__RANGE_RETURN_AMB_COUNT

31	30	29	28	27	26	25	24	23	22	21	20	19	18	17	16	15	14	13	12	11	10	9	8	7	6	5	4	3	2	1	0
result__range_return_amb_count																															
R																															

Address: 0x074**Type:** R**Reset:** 0x0**Description:**

[31:0]	result__range_return_amb_count: sensor count output value attributed to uncorrelated ambient signal on the Return array. Must be multiplied by 6 if used to calculate the ambient to signal threshold.
--------	--

6.2.41 RESULT__RANGE_REFERENCE_AMB_COUNT

31	30	29	28	27	26	25	24	23	22	21	20	19	18	17	16	15	14	13	12	11	10	9	8	7	6	5	4	3	2	1	0
result__range_reference_amb_count																															
R																															

Address: 0x078**Type:** R**Reset:** 0x0**Description:**

[31:0]	result__range_reference_amb_count: sensor count output value attributed to uncorrelated ambient signal on the Reference array.
--------	--

6.2.42 RESULT__RANGE_RETURN_CONV_TIME

31	30	29	28	27	26	25	24	23	22	21	20	19	18	17	16	15	14	13	12	11	10	9	8	7	6	5	4	3	2	1	0
result__range_return_conv_time																															
R																															

Address: 0x07C

Type: R

Reset: 0x0

Description:

[31:0]	result__range_return_conv_time: sensor count output value attributed to signal on the Return array.
--------	---

6.2.43 RESULT__RANGE_REFERENCE_CONV_TIME

31	30	29	28	27	26	25	24	23	22	21	20	19	18	17	16	15	14	13	12	11	10	9	8	7	6	5	4	3	2	1	0
result__range_reference_conv_time																															
R																															

Address: 0x080

Type: R

Reset: 0x0

Description:

[31:0]	result__range_reference_conv_time: sensor count output value attributed to signal on the Reference array.
--------	---

6.2.44 READOUT__AVERAGING_SAMPLE_PERIOD

7	6	5	4	3	2	1	0
readout__averaging_sample_period							
R/W							

Address: 0x10A

Type: R/W

Reset: 0x30

Description:

[7:0]	readout__averaging_sample_period: The internal readout averaging sample period can be adjusted from 0 to 255. Increasing the sampling period decreases noise but also reduces the effective max convergence time and increases power consumption: Effective max convergence time = max convergence time - readout averaging period (see Section 2.6: Range timing). Each unit sample period corresponds to around 64.5 μs additional processing time. The recommended setting is 48 which equates to around 4.3 ms.
-------	---

6.2.45 FIRMWARE__BOOTUP

7	6	5	4	3	2	1	0
RESERVED							firmware__bootup
R							R/W

Address: 0x119

Type: R/W

Reset: 0x1

Description:

[0]	firmware__bootup: FW must set bit once initial boot has been completed.
-----	---

6.2.46 I2C_SLAVE__DEVICE_ADDRESS

7	6	5	4	3	2	1	0
RESERVED	super_i2c_slave__device_address						
R	R/W						

Address: 0x212

Type: R/W

Reset: 0x29

[6:0]	super_i2c_slave__device_address: User programmable I ² C address (7-bit). Device address can be re-designated after power-up.
-------	--

7 Outline drawing

Figure 29. Outline drawing - module - VL6180V1NR/1 - (page 1/2)

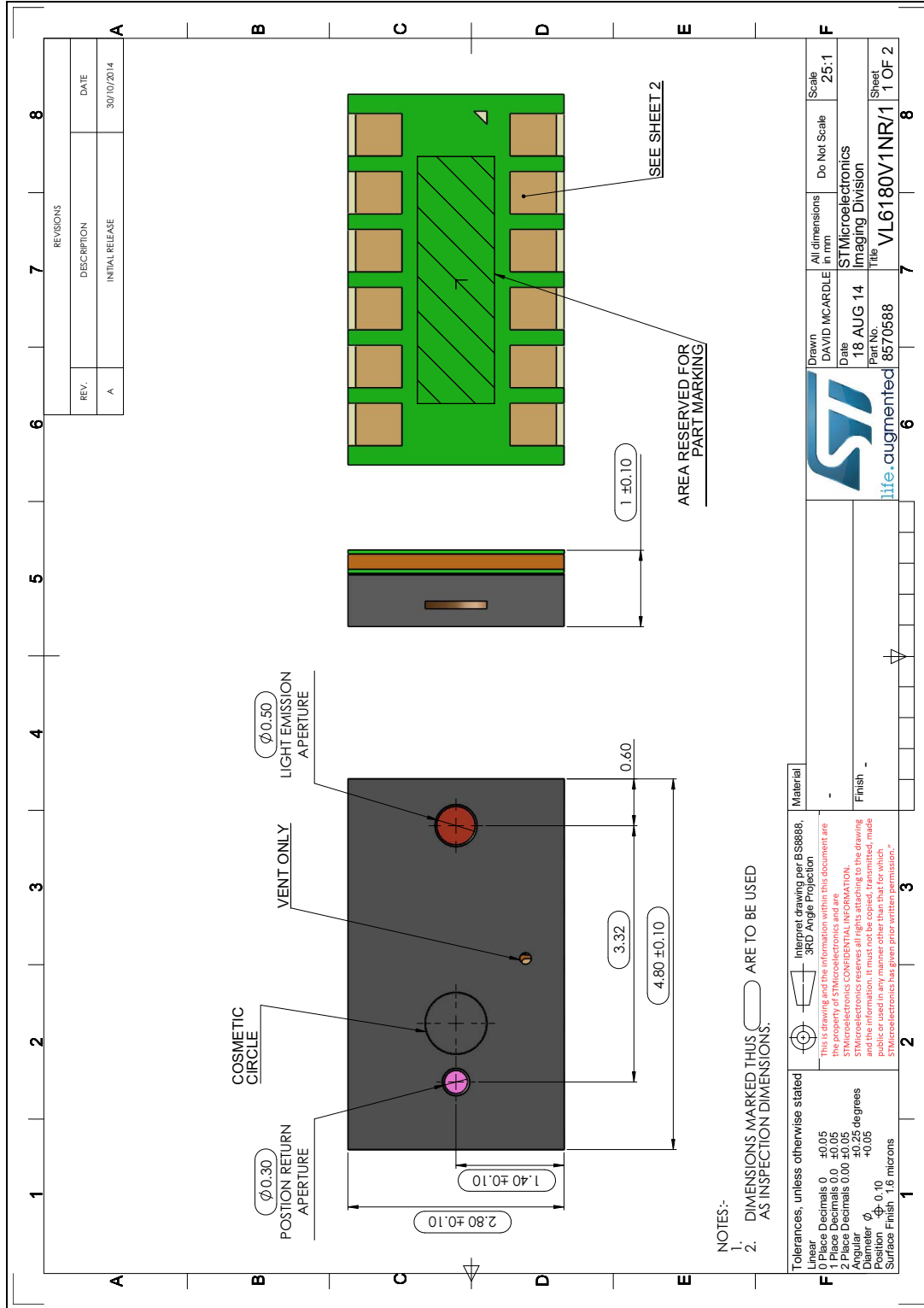
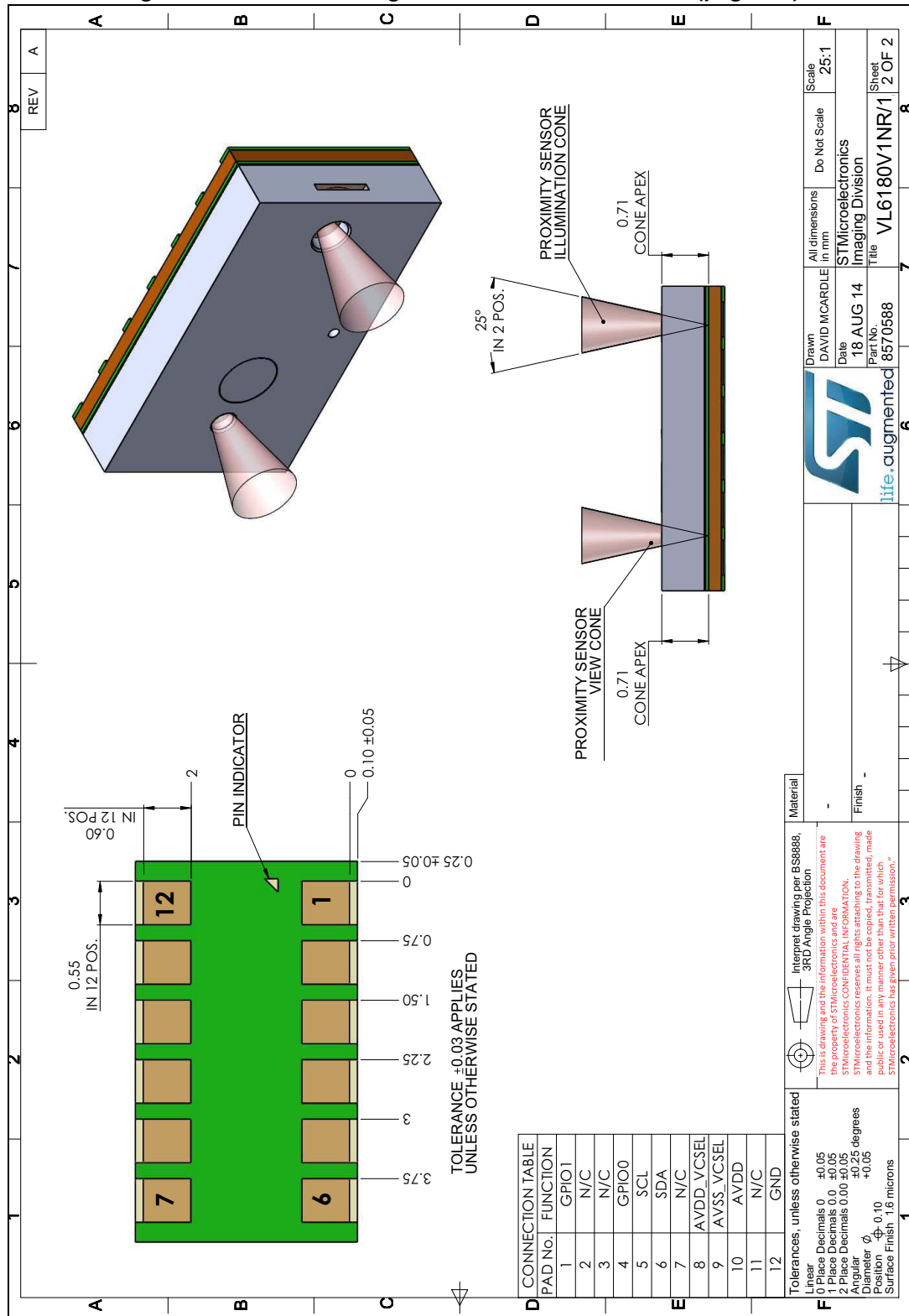

Figure 30. Outline drawing - module - VL6180V1NR/1 - (page 2/2)



8 Laser safety considerations

The VL6180 contains a laser emitter and corresponding drive circuitry. The laser output is designed to remain within Class 1 laser safety limits under all reasonably foreseeable conditions including single faults in compliance with IEC 60825-1:2007. The laser output will remain within Class 1 limits as long as the STMicroelectronics recommended device settings are used and the operating conditions specified in this datasheet are respected. The laser output power must not be increased by any means and no optics should be used with the intention of focusing the laser beam.

Figure 31. Class 1 laser product label



8.1 Compliance

Complies with 21 CFR 1040.10 and 1040.11 except for deviations pursuant to Laser Notice No.50, dated June 24, 2007.

9 Ordering information

VL6180 is currently available in the following format. More detailed information is available on request.

Table 26. Delivery format

Order code	Description
VL6180V1NR/1	Tape and reel (5000 units in a reel).

9.1 Traceability and identification

Latest ROM revision can be identified as follows:

0x002 IDENTIFICATION__MODEL_REV_MINOR = 3

The minimum information required for traceability is the content of the following registers:

0x006 - IDENTIFICATION__DATE_HI

0x007 - IDENTIFICATION__DATE_LO

0x008 - IDENTIFICATION__TIME (16-bit)

0x00A - IDENTIFICATION__CODE

With this information, the module can be uniquely identified.

Preferably, all the IDENTIFICATION register contents should be provided for traceability.

9.2 Part marking

Devices are marked on the underside as shown below. 1st line is the product ID. 2nd line is the manufacturing info. (circled in green), where the 1st four letters are the lot ID and the last 3 digits are the year + week number. Here: 338 is 2013 wk38. The final letter, circled in red, is the ROM revision ('E').

Figure 32. Part marking

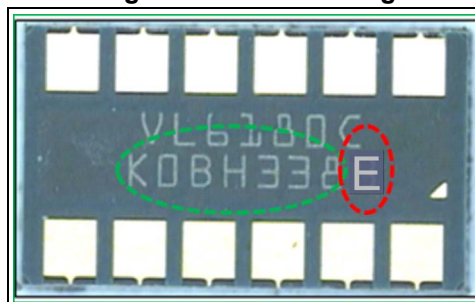

9.3 Packaging

The VL6180 is available in tape and reel packaging as shown in [Figure 33](#). All dimensions are in mm.

Figure 33. Tape and reel packaging

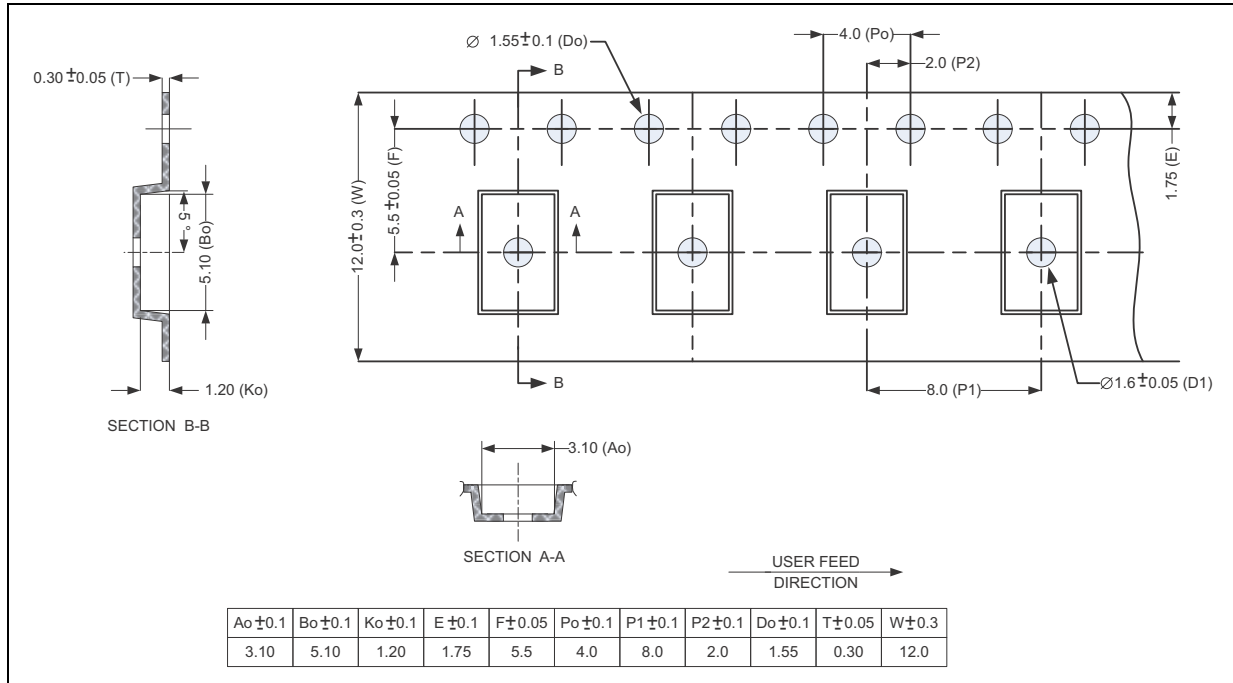

9.3.1 Package labeling

The labeling on the packing carton is shown in [Figure 34](#). The latest ROM revision is indicated alongside the order code (shaded green) and also after the product marking (shaded pink).

Figure 34. Package labeling

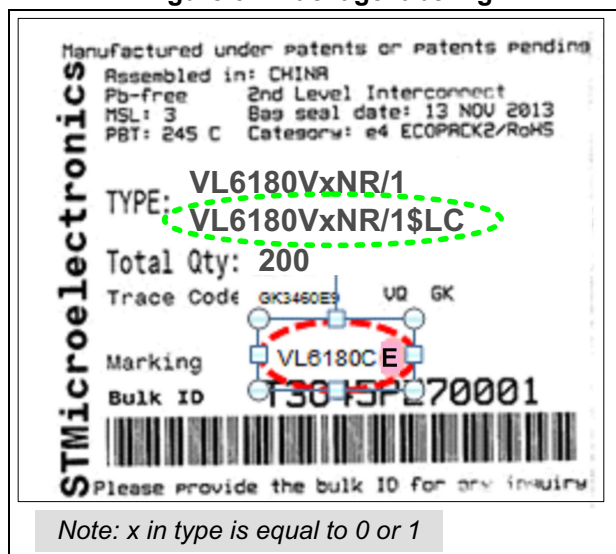

9.4 Storage

The VL6180 is a MSL 3 package.

Table 27. Storage conditions

Level	Floor Life (out of bag) at Factory Ambient <30°C/60% RH
3	1 Week

After this limit, dry bake to be done; 6 hours at 85°C.

9.5 ROHS Compliance

The VL6180 is Ecopack2 compliant as per ST definition.

Devices which are ROHS compliant even with use of ROHS exemption(s) and free of Halogenated flame retardant are named ECOPACK2 devices with the following definition:

- ROHS compliant even with use of ROHS exemption(s)
- 500 ppm maximum of Antimony as oxide or organic compound in each organic assembly material (glue, substrate, mold compounds, housing...). Antimony in ceramic parts, in glass and in solder alloy is not restricted.
- 900 ppm maximum Bromine + Chlorine in each organic assembly material (glue, substrate, mold compounds, housing...)

These values are referring to maximum total content not to extractable ions content. Purchasing specification of assembly materials can impose lower values for technical reasons.

ECOPACK2 devices are of course fully compliant to ST banned and declarable substances specification and for example cannot contain red Phosphorus flame retardant.

10 ECOPACK®

In order to meet environmental requirements, ST offers these devices in different grades of ECOPACK® packages, depending on their level of environmental compliance. ECOPACK® specifications, grade definitions and product status are available at: www.st.com. ECOPACK® is an ST trademark.

11 Revision history

Table 28. Document revision history

Date	Revision	Changes
23-Sep-2013	1	Initial release.
30-Jan-2014	1.1	General update for latest ROM revision: <i>Section 1.1: Technical specification</i> updated <i>Section 1.4: Typical application schematic</i> updated <i>Section 1.5: Recommended solder pad dimensions</i> updated Notes added to <i>Figure 5.: Recommended reflow profile</i> <i>Section 4: I2C control interface</i> updated. <i>Section 5.1: Absolute maximum ratings</i> added <i>Section 5.2: Normal operating conditions</i> extended <i>Section 4: I2C control interface</i> added Revised outline drawing added to <i>Section 7: Outline drawing</i> Class 1 laser product label added to <i>Section Figure 29.: Outline drawing - module - VL6180V1NR/1 - (page 1/2)</i> <i>Section 8.1: Compliance</i> added information relating to device marking and package labeling
20-Feb-2014	1.2	<i>Section 6.2.32: RESULT_INTERRUPT_STATUS_GPIO</i> corrected error codes. <i>Section 4: I2C control interface</i> updated to show ranging beyond 100mm. <i>Section 6.2.20: SYSRANGE_MAX_CONVERGENCE_TIME</i> updated.
28-Feb-2014	1.3	<i>Section Figure 21.: Typical ranging performance</i> updated to add the concept of detection rate..
24-Mar-2014	2	Update to the following sections: <i>Section 1.5: Recommended solder pad dimensions</i> <i>Section 5.2: Normal operating conditions</i> <i>Section 5.3: Electrical characteristics</i> <i>Section 3.1: Proximity ranging (0 to 100mm)</i> <i>Section Figure 21.: Typical ranging performance</i> Added <i>11: Revision history</i> and <i>Appendix B: Extended range settings</i>
10-Jun-2014	3	Added outline drawing of 2nd module cap supplier in <i>Section 7: Outline drawing</i> Added <i>Section 8.1: Compliance</i>
12-Jun-2014	4	Update with single outline drawing
7-Jul-2014	5	Updates: <i>Figure 32: Part marking</i> <i>Figure 34: Package labeling</i>
20-Aug-2014	6	Updates: <i>Section 2: Functional description</i> <i>Section 6: Device registers</i> Typical ranging performance graph updated. Delivery & manufacturing info updated.

Table 28. Document revision history (continued)

Date	Revision	Changes
6-Nov-2014	7	Add: - Figure 29 and Figure 30 - VL6180V1NR/1 ordering code in Table 26 . Modify title of Figure 29 and Figure 29 Update package figure on first page and Figure 34
11-Dec-2014	8	Updates: – Figure 20: Cross-talk vs air gap
17-Dec-2014	9	Add – Footnote below Table 1: Technical specification – Section 2.2: System state diagram Update: – Section 2.15.4: Cross-talk calibration procedure – Section 6.2.4: IDENTIFICATION_MODULE_REV_MAJOR – Section 6.2.5: IDENTIFICATION_MODULE_REV_MINOR Move – Figure 21: Typical ranging performance to Section 3.1: Proximity ranging (0 to 100mm)
15-Oct-2015	10	Updates: – API integrated into datasheet – Section 2.14.3: Current distribution – Section 2.15.3: Offset calibration procedure – Section 2.15.4: Cross-talk calibration procedure Add: – Section 2.11: Wrap Around Filter – Section 2.12: Scaling – Section 2.13: Maximum ranging distance (Dmax) – Section 4.1: I2C interface - timing characteristics
11-May-2016	11	Update: – Section 2.15.6: Cross-talk vs air gap , keep only one figure.
13-Mar-2017	12	Remove VL6180V0NR/1 device version
28-Feb-2020	13	Removed confidential watermark

IMPORTANT NOTICE – PLEASE READ CAREFULLY

STMicroelectronics NV and its subsidiaries (“ST”) reserve the right to make changes, corrections, enhancements, modifications, and improvements to ST products and/or to this document at any time without notice. Purchasers should obtain the latest relevant information on ST products before placing orders. ST products are sold pursuant to ST’s terms and conditions of sale in place at the time of order acknowledgement.

Purchasers are solely responsible for the choice, selection, and use of ST products and ST assumes no liability for application assistance or the design of Purchasers’ products.

No license, express or implied, to any intellectual property right is granted by ST herein.

Resale of ST products with provisions different from the information set forth herein shall void any warranty granted by ST for such product.

ST and the ST logo are trademarks of ST. For additional information about ST trademarks, please refer to www.st.com/trademarks. All other product or service names are the property of their respective owners.

Information in this document supersedes and replaces information previously supplied in any prior versions of this document.

© 2020 STMicroelectronics – All rights reserved